

Cast iron for slab-on-grade applications

664 Series

Features and benefits:

Multiple-service floor boxes deliver power, communications and data from standard conduit with no exposed service fittings. Result: Open office planning flexibility. Ideal for the modern office with workstations that have power, communications and data equipment. Power receptacles and low-voltage connections can be enclosed underfloor in either steel or cast-iron bodies. Galvanized 14-gauge steel boxes are provided with knockouts from 3/4" to 1 1/4" (see engineering data). Cast-iron bodies have threaded openings for 3/4" and 1" conduit.

- Two-compartment box is available in three configurations: stamped steel (664-SC), shallow (664-S) (see page C52) and cast iron (664-CI)
- Durable nonmetallic covers include a steel reinforcement plate for added strength
- Metallic covers in solid brass, aluminum and aluminum black powder-coated provide aesthetics and durability
- Cover flange self-levels with the finished floor for easy installation



Diagrams

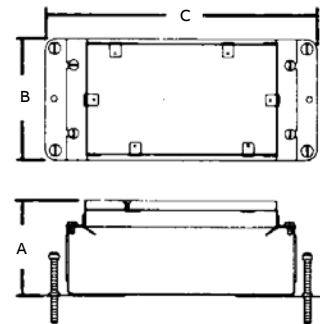

Cat. No.	Description	Std. Ctn.
664-CI	Cast-iron box which accepts two plates, with one duplex 664-RP provided	1

Note: When ordering a 664 Series box, the cover must be ordered separately. See page C14. For communications accessories, see page C113.

Engineering data for 664 Series



Cat. No.	Dimensions (in.)			Before Pour Adj. (in.)	After Pour Adj. (in.)	Maximum capacity (cu. in.)	Conduit Hubs	Conduit KOs		
	A	B	C					Sides	Bottom	Covers
664-CI	3 3/4	5 3/32	9 15/16	2 1/2	3/4	24 per gang, 90 total	(4) 3/4" (4) 1"	—	—	664-CST Series

CAUTION: When using the center side KOs, Cat. No. 664-RP must be assembled to the box prior to installing the conduit.

Nonmetallic covers

664 Series

Covers for all boxes

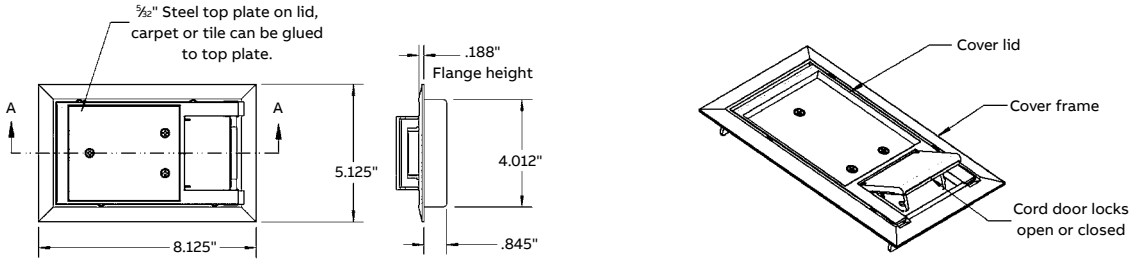

664-CST-SW

MopTite covers meet UL/CSA scrubwater exclusion requirements for carpet, tile and wood.



Cat. No.	Description	Load Rating (lb)	Std. Ctn.
664-CST-SW-GRY	Grey cover	1,500	1
664-CST-SW-BRN	Brown cover	1,500	1
664-CST-SW-BGE	Beige cover	1,500	1
664-CST-SW-BLK	Black cover	1,500	1

Metallic covers

664 Series



664-CST-M-BRS
Solid brass



664-CST-M-ALM
Solid aluminum



664-CST-M-BLK
Solid aluminum cover, black powder coated

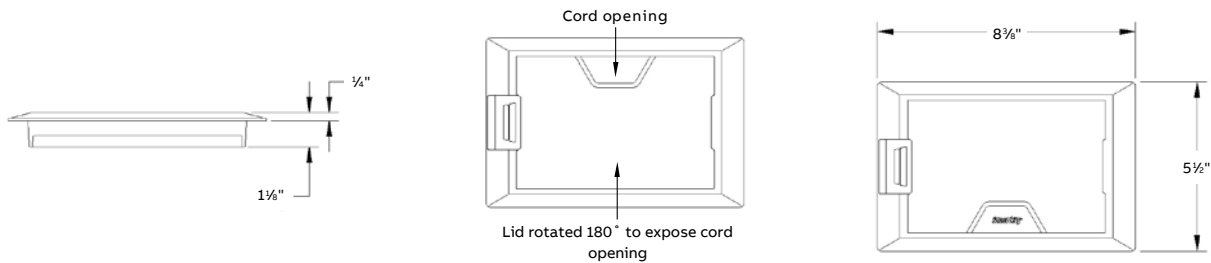

MopTite covers meet UL/CSA scrubwater exclusion requirements for carpet, tile and wood.



Cat. No.	Description	Load Rating (lb)	Std. Ctn.
664-CST-M-BRS	Solid brass cover for 664 Series floor boxes	2,250	1
664-CST-M-ALM	Solid aluminum cover for 664 Series floor boxes	2,250	1
664-CST-M-BLK	Solid aluminum cover, black powder coated for 664 Series floor boxes	2,250	1

Wire tunnel

664 Series

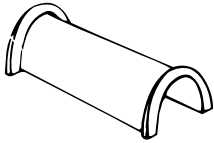

664-WT

- Wire tunnel for protecting electrical connections between the two receptacles when the box is used for power/power application



Cat. No.	Description	Std. Ctn.
664-WT	For use with 664 and 664-CI floor boxes	4

Device plates

664-SC & 664-CI

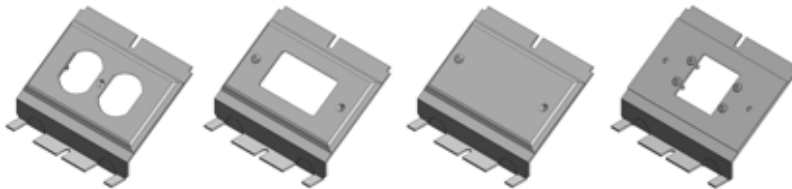

664-RP

664-GP

664-BP

664-2-MAAP

- Receptacle face plate for 664 Series floor box for additional power service
- Does not include receptacle. Can be placed at either end of floor box



Cat. No.	Description	Std. Ctn.
664-RP	For use with 664 and 664-CI floor boxes	4
664-BP	Blank plate for use with 664 & 664-CI floor boxes	4
664-GP	GFCI receptacle plate	4
664-2-MAAP	Device panel, accepts 2 Extron® MAAP plates	4

CAUTION: When using the center side KOs, all 664 plates must be assembled to the box prior to installing the conduit.

Cast iron for slab-on-grade applications

665 Series - 665-CI

The Steel City 665 cast iron floor box provides a high-capacity power and data solution for ground-floor installations. This 4-gang recessed service floor box is ideal for slab-on-grade applications. Removable voltage dividers enable users to customize wiring configurations by feeding two or more adjacent compartments with a single conduit. Aesthetic covers feature a recess to accept floor covering to match the surrounding floor.



Features and benefits:

- 4-gang, recessed service for a high-capacity aesthetic floor-box solution
- Removable voltage dividers between compartments enable a single conduit to feed two or more adjacent compartments heavy duty, nonmetallic covers with steel reinforcement plates are available in a wide variety of colors to match any decor (black, grey, brown and beige)
- Metallic covers
- Separate cord door in the cover latches firmly in the open position to prevent damage to cables
- MopTite covers meet UL/CSA scrubwater exclusion requirements for carpet, tile and wood
- Largest cubic-inch capacity of any cast iron recessed 4-gang floor box
- Inline 1 1/4" hubs allow high-capacity straight runs for communicator wiring
- Custom device panels and hub sizes are available. Contact technical service about these offerings



Cat. No.	Description	Device compartments (in.)						Std. Ctn.
		Length	Width	Height	Area	Device Access Area		
665-CI	Cast iron box	5 3/4	3 1/2	2 1/4	45 cu. in.	126 cu. in.	1	

665-CI floor box does not include device plates or cover. Order separately. (See page C17)
For communications accessories, see page C113.

Diagrams

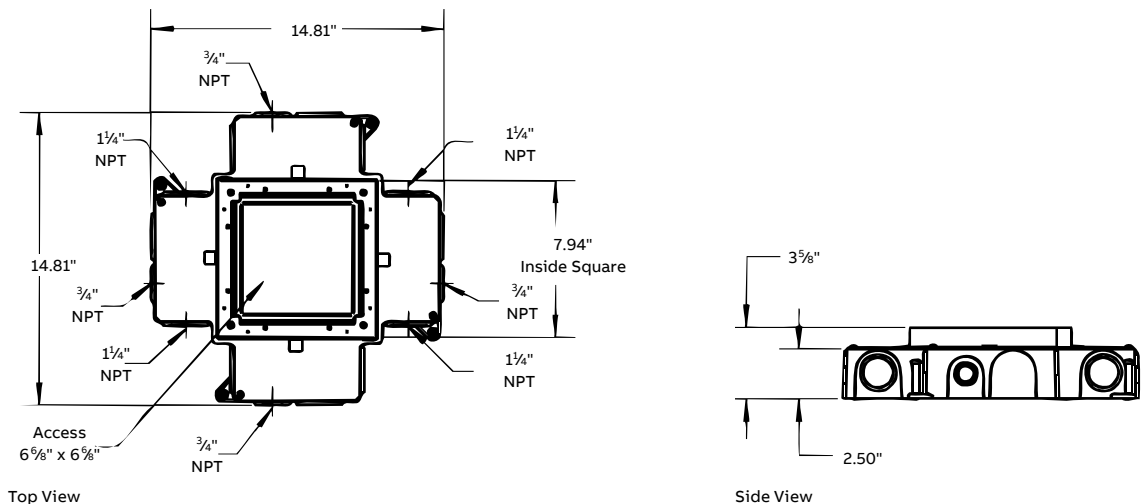

Metallic covers

665 Series



665-CST-M-BRS
Solid brass

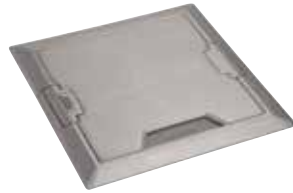

665-CST-M-ALM
Solid aluminum



665-CST-M-BLK
Solid aluminum, black powder coated

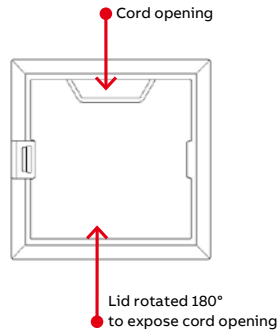
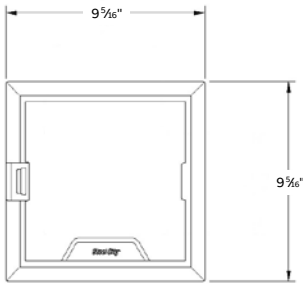

Cat. No.	Description	Load Rating (lb)	Std. Ctn.
665-CST-M-BRS	Solid brass cover for 665 Series floor boxes	1,500	1
665-CST-M-ALM	Solid aluminum cover for 665 Series floor boxes	1,500	1
665-CST-M-BLK	Solid aluminum cover, black powder coated for 665 Series floor boxes	1,500	1

Nonmetallic covers

665 Series



665-CST-SW-BLK
Black nonmetallic cover

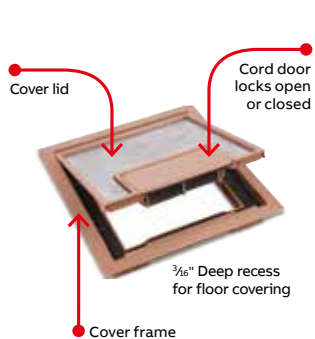

5/32" Steel top plate on lid, carpet or tile can be glued to top plate.

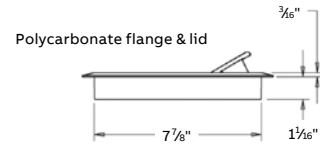
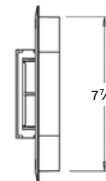
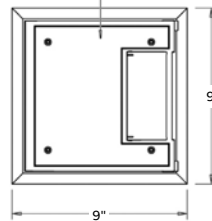

Cat. No.	Description	Load Rating (lb)	Std. Ctn.
665-CST-SW-BLK	Nonmetallic cover for 665 Series floor boxes, black	750	1
665-CST-SW-GRY	Nonmetallic cover for 665 Series floor boxes, grey	750	1
665-CST-SW-BGE	Nonmetallic cover for 665 Series floor boxes, beige	750	1
665-CST-SW-BRN	Nonmetallic cover for 665 Series floor boxes, brown	750	1

Furnished with (4) #8-32 x 3/8" mounting screws.
Contact ABB Technical Service for Color Chip samples.

Device plates and accessories

665 Series



665-RP
Duplex plate



665-GP
GFCI plate



665-BP
Blank plate



665-6RJ
Data plate for 6 keystone jacks



665-WT
Wire tunnel feeds multiple compartments from a single conduit (one included with each 665-AV2 and 665-SC)



Cat. No.	Description	Std. Ctn.
665-RP	Duplex plate for 665 Series floor boxes	4
665-GP	GFCI plate for 665 Series floor boxes	4
665-BP	Blank plate for 665 Series floor boxes	4
665-6RJ	Data plate for 665 Series floor boxes, accepts 6 keystone jacks	4
665-STEL	Telephone data plate for 665 Series floor boxes	4
665-WT	Replacement wire tunnel for 665-SC, 665-CI & 665-AV2 floor boxes	4

Each box requires (4) device plates.

Diagrams

