

## Aluminum lugs

### One-hole CSA die lugs

- Use with aluminum and copper conductors
- Provides high strength and high conductivity
- Prevents oxidation and keeps out moisture
- Easy identification
- Meet or exceed ANSI C119.4 specifications

#### One-hole CSA die lugs

Cat. no.	Wire size	CSA die	O.D.	I.D.	L	B	P	Dimensions (in.)		
								W	C	T
GLE 2-48	2 str.-Compr-CPT	22	0.635	0.340	3.13	1.37	1.31	0.88	0.63	0.20
GLE 1/0-48	1/0 str.-Compr-CPT	22	0.640	0.420	3.13	1.37	1.31	0.88	0.63	0.21
GLE 2/0-48	2/0 str. Compr-CPT	24	0.840	0.503	3.44	1.37	1.31	1.14	0.63	0.28
GLE 3/0-48	3/0 str.-Compr-CPT	24	0.840	0.547	3.44	1.37	1.31	1.14	0.63	0.28
GLE 4/0-48	4/0 str.-Compr-CPT	24-6T	0.840	0.597	3.44	1.37	1.31	1.14	0.63	0.28
GLE 250-48	250 str.-Compr-CPT	26	1.000	0.620	3.75	1.63	1.31	1.25	0.63	0.36
GLE 300-48	300 str.-Compr-CPT	26-12T	1.000	0.670	3.75	1.63	1.31	1.25	0.63	0.36
GLE 350-48	350 str.-Compr-CPT	28	1.189	0.730	3.75	1.63	1.31	1.25	0.63	0.34
GLE 500-48	500 str.-Compr-CPT	28-12T	1.187	0.836	3.75	1.63	1.31	1.25	0.63	0.36
GLE 500-48-30	500 str.-Compr-CPT	30-12T	1.438	0.880	5.00	2.50	1.50	1.75	0.63	0.52
GLE 750-48	750 str.-Compr-CPT	30	1.438	1.031	5.88	3.00	1.88	1.75	0.88	0.56

#### Diagrams

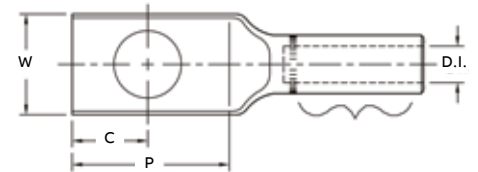

Marking information \_\_\_\_\_

Cat. no. \_\_\_\_\_

Wire size \_\_\_\_\_

Die size \_\_\_\_\_

# of crimps and locations  
to be determined  
according to connector

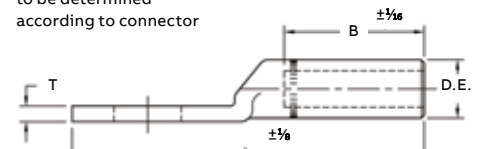

**Finish:** Tin-plated optional, use suffix "-TN".

**Material:** E.C. grade aluminum.

Connector bores are coated with HM 53 (an oxide-inhibiting compound) and capped.

Mounting holes sized for 1/2" bolts (9/16" hole size).

Optional suffix "-38" for 3/8" bolts (19/32" hole size).

# Aluminum lugs

## Two-hole CSA die lugs

- Use with aluminum and copper conductors
- Provides high strength and high conductivity
- Prevents oxidation and keeps out moisture
- Easy identification
- Meet or exceed ANSI C119.4 specifications

### Two-hole CSA die lugs

Cat. no.	Wire size	CSA die	O.D.	I.D.	Dimensions (in.)				
					L	B	P	W	T
GLE 2 N	2 str.–Compr–CPT	22	0.635	0.350	5.29	1.50	3.13	0.88	0.20
GLE 1/0 N	1/0 str.–Compr–CPT	22	0.640	0.420	5.25	1.50	3.13	0.87	0.21
GLE 2/0 N	2/0 str. Compr–CPT	24	0.840	0.503	5.29	1.50	3.13	1.04	0.28
GLE 3/0 N	3/0 str.–Compr–CPT	24	0.840	0.547	5.38	1.50	3.13	1.14	0.28
GLE 4/0 N	4/0 str.–Compr–CPT	24–6T	0.840	0.594	5.38	1.50	3.13	1.14	0.28
GLE 250 N	250 str.–Compr–CPT	26	1.000	0.620	6.00	2.00	3.13	1.25	0.36
GLE 300 N	300 str.–Compr–CPT	26–12T	1.000	0.670	6.00	2.00	3.13	1.25	0.36
GLE 350 N	350 str.–Compr–CPT	28	1.189	0.730	6.00	2.00	3.13	1.25	0.37
GLE 500 N	500 str.–Compr–CPT	28–12T	1.187	0.836	6.38	2.25	3.13	1.25	0.37
GLE 500 N-30	500 str.–Compr–CPT	30	1.438	0.880	6.38	2.50	3.13	1.75	0.40
GLE 750 N	750 str.–Compr–CPT	30	1.438	1.031	7.50	3.00	3.13	1.75	0.40

### Diagrams

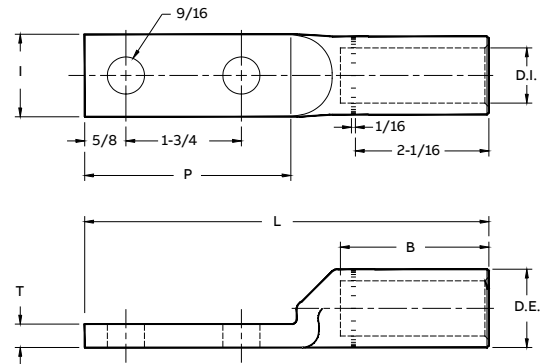

**Finish:** Tin-plated optional, use suffix “-TN”.

**Material:** E.C. grade aluminum.

Connector bores are coated with HM 53 (an oxide-inhibiting compound) and capped.

Mounting holes sized for 1/2" bolts (9/16" hole size).

Optional suffix “-38” for 3/8" bolts (19/32" hole size).

## Aluminum lugs

### One-hole NEMA die lugs



AL 500-48

#### General-purpose lugs for aluminum and copper terminations

- Use with aluminum and copper conductors
- Provides high strength and high conductivity
- Prevents oxidation and keeps out moisture
- Easy identification
- Meets or exceeds ANSI C119.4 specifications

#### One-hole NEMA die lugs

Cat. no.	Conductor range (AWG or kcmil)				Bolt size	Installing dies	Dimensions (in.)			
	Concentric	Compressed	Compact	ACSR			B	L	P	W
AL 6-14	#6	-	-	-	¼	TP, 29, 161, ⅝	¾	2 <sup>5</sup> / <sub>32</sub>	⅞	9 <sup>1</sup> / <sub>16</sub>
AL 4-516	#4				⅝	TB, 37, 375, 162	1 <sup>5</sup> / <sub>16</sub>	2¼	3 <sup>1</sup> / <sub>32</sub>	⅝
AL 4-14					¼		1 <sup>5</sup> / <sub>16</sub>	2¼	3 <sup>1</sup> / <sub>32</sub>	⅝
AL 2-14	#2				¼	TQ, 45, 348, 163, ½, 6A	5 <sup>9</sup> / <sub>64</sub>	2 <sup>5</sup> / <sub>8</sub>	1 <sup>1</sup> / <sub>32</sub>	¾
AL 2-38					⅜		5 <sup>9</sup> / <sub>64</sub>	2 <sup>5</sup> / <sub>8</sub>	1 <sup>1</sup> / <sub>32</sub>	¾
AL 1-38	#1				⅜		5 <sup>9</sup> / <sub>64</sub>	2 <sup>5</sup> / <sub>8</sub>	1 <sup>1</sup> / <sub>32</sub>	¾
AL 1/0-38	1/0				⅜	TU, 52, BG, 243, ⅝	1 <sup>3</sup> / <sub>8</sub>	3 <sup>3</sup> / <sub>8</sub>	1 <sup>5</sup> / <sub>16</sub>	⅞
AL 1/0-48					½		1 <sup>3</sup> / <sub>8</sub>	3 <sup>3</sup> / <sub>8</sub>	1 <sup>5</sup> / <sub>16</sub>	⅞
AL 2/0-38	2/0				⅜	TW-TY, 58, 297, ⅝-1	1 <sup>5</sup> / <sub>16</sub>	3 <sup>3</sup> / <sub>16</sub>	1 <sup>7</sup> / <sub>32</sub>	1 <sup>5</sup> / <sub>16</sub>
AL 2/0-48					½		1 <sup>5</sup> / <sub>16</sub>	3 <sup>3</sup> / <sub>16</sub>	1 <sup>7</sup> / <sub>32</sub>	1 <sup>5</sup> / <sub>16</sub>
AL 3/0-38	3/0				⅜	737, 467	1 <sup>5</sup> / <sub>16</sub>	3 <sup>7</sup> / <sub>16</sub>	1 <sup>5</sup> / <sub>16</sub>	1 <sup>1</sup> / <sub>16</sub>
AL 3/0-48					½		1 <sup>5</sup> / <sub>16</sub>	3 <sup>7</sup> / <sub>16</sub>	1 <sup>5</sup> / <sub>16</sub>	1 <sup>1</sup> / <sub>16</sub>
AL 4/0-38	4/0				⅜	TX, 71H, 298, 840, 11A	1 <sup>7</sup> / <sub>16</sub>	3 <sup>3</sup> / <sub>16</sub>	1 <sup>11</sup> / <sub>32</sub>	1 <sup>3</sup> / <sub>16</sub>
AL 4/0-48					½		1 <sup>7</sup> / <sub>16</sub>	3 <sup>3</sup> / <sub>16</sub>	1 <sup>11</sup> / <sub>32</sub>	1 <sup>3</sup> / <sub>16</sub>
AL 250-48	250, 4/0			4/0	½	TX, 76, 249, 840, 11A	1 <sup>7</sup> / <sub>16</sub>	3 <sup>5</sup> / <sub>8</sub>	1 <sup>5</sup> / <sub>16</sub>	1 <sup>15</sup> / <sub>64</sub>
AL 300-48	300, 266.8		350	266.8 (18/1)	½	TH, 87H, 251, 470, 1, 12A	2 <sup>3</sup> / <sub>16</sub>	4	1 <sup>5</sup> / <sub>16</sub>	1 <sup>3</sup> / <sub>8</sub>
AL 350-48	350, 336.4		400	266.8 (26/7), 336.4 (18/1)	½	96, 299, 655, 1½-1, 13A	2 <sup>3</sup> / <sub>16</sub>	4¼	1 <sup>5</sup> / <sub>16</sub>	1½
AL 400-48	400, 397.5		-	336.4 (26/7), 397.5 (18/1)	½		2½	4 <sup>7</sup> / <sub>8</sub>	1¼	1 <sup>5</sup> / <sub>8</sub>
AL 400-58					⅝		2½	4 <sup>7</sup> / <sub>8</sub>	1¼	1 <sup>5</sup> / <sub>8</sub>
AL 500-48	500, 477		600	379.5 (26/7), 477 (18/1)	½	106A, 300, 317, 1 <sup>5</sup> / <sub>16</sub> , 14A	3	5 <sup>7</sup> / <sub>16</sub>	1½	1¾
AL 500-58					⅝		3	5 <sup>7</sup> / <sub>16</sub>	1½	1¾
AL 600-48	600, 550		-	477 (26/7), 556.5 (18/1)	½	1 <sup>5</sup> / <sub>16</sub> , 115H, 786, 936, 473	3	5 <sup>21</sup> / <sub>32</sub>	1 <sup>9</sup> / <sub>16</sub>	1 <sup>15</sup> / <sub>16</sub>
AL 600-58					⅝		3	5 <sup>21</sup> / <sub>32</sub>	1 <sup>9</sup> / <sub>16</sub>	1 <sup>15</sup> / <sub>16</sub>
AL 750-48	750, 700			636 (26/7)	½	140H, 301, 342, 1½	3 <sup>3</sup> / <sub>8</sub>	6 <sup>3</sup> / <sub>8</sub>	1 <sup>7</sup> / <sub>8</sub>	1¾
AL 750-58					⅝		3 <sup>3</sup> / <sub>8</sub>	6 <sup>3</sup> / <sub>8</sub>	1 <sup>7</sup> / <sub>8</sub>	1¾
AL 800-48	800			-	½	1½, 474, 140H	3 <sup>3</sup> / <sub>16</sub>	6 <sup>5</sup> / <sub>8</sub>	2 <sup>1</sup> / <sub>32</sub>	1¾
AL 800-58					⅝		3 <sup>3</sup> / <sub>16</sub>	6 <sup>5</sup> / <sub>8</sub>	2 <sup>1</sup> / <sub>32</sub>	1¾
AL 1000-48	1000, 954			795 (26/7), 954 (45/7)	½	161, 292, 302, 319, 1¾	4 <sup>3</sup> / <sub>8</sub>	7 <sup>15</sup> / <sub>16</sub>	1 <sup>7</sup> / <sub>8</sub>	2 <sup>7</sup> / <sub>16</sub>
AL 1000-58					⅝		4 <sup>3</sup> / <sub>8</sub>	7 <sup>15</sup> / <sub>16</sub>	1 <sup>7</sup> / <sub>8</sub>	2 <sup>7</sup> / <sub>16</sub>

#### Diagrams

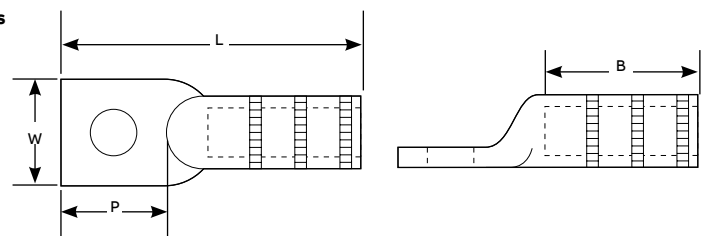

For tin-plated, add "TN" suffix to the catalogue number. All tin-plated lugs are UL listed through 1000 kcmil.  
For straight lugs with tapered ends used in high-voltage applications, please consult your ABB representative.

# Aluminum lugs

## Two-hole NEMA die lugs

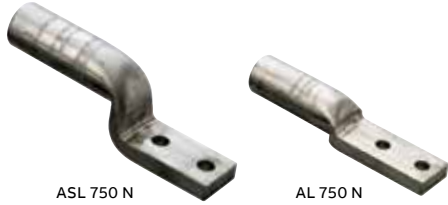

### General-purpose lugs for aluminum and copper terminations

- Use with aluminum and copper conductors
- Provides high strength and high conductivity
- Prevents oxidation and keeps out moisture
- Easy identification
- Meets or exceeds ANSI C119.4 specifications

### Two-hole NEMA die lugs

Straight lug Cat. no.	Stacking lug Cat. no.	Conductor range (AWG or kcmil)						Dimensions (in.)			
		Concentric	Compr.	Compact	ACSR	Solid	Installing dies	B	L	P	W
SA 6 N	ASL 6 N	#6	#6	#6, #4	#6	4	TU, 52, BG, 243, 5/8, CSA 22	1 <sup>15</sup> / <sub>32</sub>	5 <sup>1</sup> / <sub>4</sub>	3 <sup>3</sup> / <sub>16</sub>	7 <sup>1</sup> / <sub>8</sub>
SA 4 N	ASL 4 N	#4	#4	-	#4	2		1 <sup>15</sup> / <sub>32</sub>	5 <sup>1</sup> / <sub>4</sub>	3 <sup>3</sup> / <sub>16</sub>	7 <sup>1</sup> / <sub>8</sub>
SA 2 N	ASL 2 N	#2-#1	#1	#1	#2	1/0		1 <sup>1</sup> / <sub>2</sub>	5 <sup>3</sup> / <sub>16</sub>	3 <sup>1</sup> / <sub>4</sub>	1
AL 1/0 N	ASL 1/0 N	1/0	-	2/0	1/0	2/0	TU, 52, BG, 243, 5/8	1 <sup>1</sup> / <sub>2</sub>	5 <sup>1</sup> / <sub>4</sub>	3 <sup>3</sup> / <sub>16</sub>	7 <sup>1</sup> / <sub>8</sub>
AL 2/0 N	ASL 2/0 N	2/0		-	-	-	TW-TY, 58, 297, 5/8-1	1 <sup>1</sup> / <sub>2</sub>	5 <sup>1</sup> / <sub>4</sub>	3 <sup>3</sup> / <sub>16</sub>	1 <sup>5</sup> / <sub>16</sub>
AL 3/0 N	ASL 3/0 N	3/0					TV, 66, 167, 467, 10A	1 <sup>7</sup> / <sub>16</sub>	5 <sup>1</sup> / <sub>2</sub>	3 <sup>1</sup> / <sub>4</sub>	1 <sup>1</sup> / <sub>16</sub>
AL 4/0 N	ASL 4/0 N	4/0					TX, 71H, 298, 840, 11A	1 <sup>15</sup> / <sub>16</sub>	6	3 <sup>11</sup> / <sub>32</sub>	1 <sup>15</sup> / <sub>64</sub>
AL 250 N	ASL 250 N	250, 4/0		250-300	4/0 (6/1)		TX, 76, 249, 840, 11A	1 <sup>15</sup> / <sub>16</sub>	6	3 <sup>11</sup> / <sub>32</sub>	1 <sup>15</sup> / <sub>64</sub>
AL 300 N	ASL 300 N	300, 266.8		350	266.8 (18/1)		TH, 87H, 251, 470, 1, 12A	2 <sup>3</sup> / <sub>16</sub>	6 <sup>9</sup> / <sub>16</sub>	3 <sup>9</sup> / <sub>16</sub>	1 <sup>11</sup> / <sub>32</sub>
AL 350 N	ASL 350 N	350, 336.4		-	266.8 (26/7), 336.4 (18/1)		96, 299, 655, 1 <sup>1</sup> / <sub>8</sub> -1, 705, 13A	2 <sup>3</sup> / <sub>16</sub>	6 <sup>9</sup> / <sub>16</sub>	3 <sup>11</sup> / <sub>16</sub>	1 <sup>3</sup> / <sub>4</sub>
AL 336 NSC	-	397.5-400			336.4 (26/7), 397.5 (18/1)		1 <sup>1</sup> / <sub>4</sub> , 99H, 317, 20AH	4 <sup>3</sup> / <sub>16</sub>	9	3 <sup>11</sup> / <sub>16</sub>	1 <sup>21</sup> / <sub>32</sub>
AL 400 N	ASL 400 N	400, 397.5					96, 472, 655, 1 <sup>1</sup> / <sub>8</sub> -1, 1 <sup>1</sup> / <sub>8</sub> -2, 705, 316, 13A	2 <sup>7</sup> / <sub>16</sub>	7 <sup>9</sup> / <sub>16</sub>	3 <sup>9</sup> / <sub>16</sub>	1 <sup>3</sup> / <sub>4</sub>
AL 500 N	ASL 500 N	500, 477		500-600	397.5 (26/7), 477 (18/1)		106A, 300, 317, 1 <sup>5</sup> / <sub>16</sub> , 14A, 15A	2 <sup>15</sup> / <sub>16</sub>	8 <sup>1</sup> / <sub>4</sub>	3 <sup>9</sup> / <sub>16</sub>	1 <sup>3</sup> / <sub>4</sub>
AL 500 N 608	-			600			608	3 <sup>1</sup> / <sub>8</sub>	8- <sup>1</sup> / <sub>4</sub>	3 <sup>9</sup> / <sub>16</sub>	1 <sup>3</sup> / <sub>4</sub>
AL 600 N	ASL 600 N	600, 550		-	477 (26/7), 556.5 (18/1)		1 <sup>1</sup> / <sub>16</sub> , 115H, 786, 936, 473	2 <sup>15</sup> / <sub>16</sub>	7 <sup>3</sup> / <sub>4</sub>	3 <sup>5</sup> / <sub>8</sub>	1 <sup>3</sup> / <sub>4</sub> *
AL 700 N 608	-	700, 600		700-795			125H, 608	3 <sup>3</sup> / <sub>8</sub>	7 <sup>3</sup> / <sub>8</sub>	3 <sup>1</sup> / <sub>2</sub>	1 <sup>3</sup> / <sub>4</sub>
AL 750 N	ASL 750 N	750, 700		-	636 (26/7)		140H, 301, 342, 1 <sup>1</sup> / <sub>2</sub>	3 <sup>5</sup> / <sub>16</sub>	8 <sup>1</sup> / <sub>4</sub>	3 <sup>3</sup> / <sub>4</sub>	1 <sup>3</sup> / <sub>4</sub> *
AL 750 N 608	ASL 750 N 608						125H, 608	3 <sup>3</sup> / <sub>8</sub>	8 <sup>1</sup> / <sub>4</sub>	3 <sup>5</sup> / <sub>8</sub>	1 <sup>3</sup> / <sub>4</sub>
AL 800 N	ASL 800 N	800, 795			663 (30/19), 715.5 (54/7)		140H, 474, 342, 724, 1 <sup>1</sup> / <sub>2</sub>	3 <sup>11</sup> / <sub>32</sub>	8 <sup>9</sup> / <sub>16</sub>	3 <sup>5</sup> / <sub>8</sub>	1 <sup>3</sup> / <sub>4</sub> *
AL 800 N 608	-	800, 700			636 (30/19), 715.5 (54/7)		608	3 <sup>1</sup> / <sub>8</sub>	8 <sup>1</sup> / <sub>4</sub>	3 <sup>5</sup> / <sub>8</sub>	1 <sup>3</sup> / <sub>4</sub>
AL 1000 N	ASL 1000 N	1000, 954			795 (26/7, 30/19), 954 (45/7)		161, 292, 302, 319, 1 <sup>1</sup> / <sub>4</sub>	4 <sup>11</sup> / <sub>16</sub>	8 <sup>9</sup> / <sub>16</sub>	3 <sup>5</sup> / <sub>8</sub>	2 <sup>7</sup> / <sub>16</sub>
AL 1000 SSN	ASL 1000 SSN	1000				-		4 <sup>11</sup> / <sub>16</sub>	9 <sup>7</sup> / <sub>8</sub>	1 <sup>7</sup> / <sub>8</sub>	2 <sup>7</sup> / <sub>16</sub>
AL 1000 NMSNP	-							4 <sup>11</sup> / <sub>16</sub>	9 <sup>1</sup> / <sub>2</sub>	3 <sup>5</sup> / <sub>8</sub>	1 <sup>3</sup> / <sub>4</sub>
AL 954 NMSNP	-				954 (54/7)			4 <sup>11</sup> / <sub>16</sub>	9 <sup>3</sup> / <sub>8</sub>	3 <sup>5</sup> / <sub>8</sub>	1 <sup>3</sup> / <sub>4</sub>
AL 1250 N	ASL 1250 N	1200-1300			1113 (45/7), 1192.5 (45/7)		161, 727, 352	4 <sup>11</sup> / <sub>16</sub>	9 <sup>11</sup> / <sub>16</sub>	3 <sup>5</sup> / <sub>8</sub>	2 <sup>21</sup> / <sub>32</sub>
AL 1750 N	ASL 1750 N	1750				-	214, 735, 225	5 <sup>1</sup> / <sub>2</sub>	10 <sup>7</sup> / <sub>8</sub>	3 <sup>7</sup> / <sub>8</sub>	3 <sup>13</sup> / <sub>32</sub>
AL 2000 N	ASL 2000 N	2000					479	6 <sup>1</sup> / <sub>16</sub>	11 <sup>15</sup> / <sub>16</sub>	3 <sup>7</sup> / <sub>8</sub>	3 <sup>13</sup> / <sub>32</sub>

### Diagrams

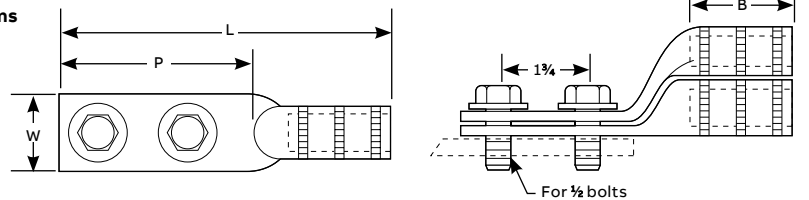

For tin-plated, add "-TN" suffix to the catalogue number. All tin-plated lugs are UL listed through 2000 kcmil. For straight lugs with tapered ends used in high-voltage applications, please consult your ABB representative. Trimmed to 1<sup>3</sup>/<sub>4</sub>" maximum to fit side-by-side on NEMA spades.

# Aluminum lugs

## Tin-plated two-hole NEMA lugs

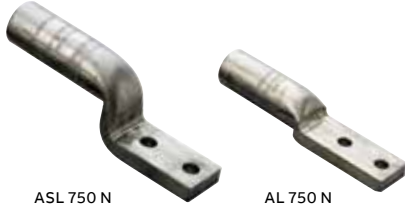

### General-purpose lugs for aluminum and copper terminations

- Use with aluminum and copper conductors
- Provides high strength and high conductivity
- Prevents oxidation and keeps out moisture
- Easy identification
- Meet or exceed ANSI C119.4 specifications

### Tin-plated tapered tees

Straight lug Cat. no.	Stacking lug Cat. no.	Conductor range (AWG or kcmil)					Installing dies	Dimensions (in.)			
		Concentric	Compr.	Compact	ACSR	Solid		B	L	P	W
SA 6 NTN	ASL 6 NTN	#6	#6	#6, #4	#6	#4	TU, 52, BG, 243, 5/8, CSA 22	1 <sup>15</sup> / <sub>32</sub>	5 <sup>3</sup> / <sub>4</sub>	3 <sup>3</sup> / <sub>16</sub>	7/8
SA 4 NTN	ASL 4 NTN	#4	#4	-	#4	#2		1 <sup>15</sup> / <sub>32</sub>	5 <sup>3</sup> / <sub>4</sub>	3 <sup>3</sup> / <sub>16</sub>	7/8
SA 2 NTN	ASL 2 NTN	#2-#1	#1	#1	#2	1/0		1 <sup>1</sup> / <sub>2</sub>	5 <sup>3</sup> / <sub>16</sub>	3 <sup>3</sup> / <sub>4</sub>	1
AL 1/0 NTN*	ASL 1/0 NTN*	1/0	-	2/0	1/0	2/0	TU, 52, BG, 243, 5/8	1 <sup>1</sup> / <sub>2</sub>	5 <sup>3</sup> / <sub>4</sub>	3 <sup>3</sup> / <sub>16</sub>	7/8
AL 2/0 NTN*	ASL 2/0 NTN*	2/0		-	-	-	TW-TY, 58, 297, 5/8-1	1 <sup>1</sup> / <sub>2</sub>	5 <sup>3</sup> / <sub>4</sub>	3- <sup>3</sup> / <sub>16</sub>	1 <sup>5</sup> / <sub>16</sub>
AL 3/0 NTN*	ASL 3/0 NTN*	3/0					TV, 66, 167, 467, 10A	1 <sup>7</sup> / <sub>16</sub>	5 <sup>1</sup> / <sub>2</sub>	3 <sup>3</sup> / <sub>4</sub>	1 <sup>1</sup> / <sub>16</sub>
AL 4/0 NTN*	ASL 4/0 NTN*	4/0					TX, 71H, 298, 840, 11A	1 <sup>15</sup> / <sub>16</sub>	6	3 <sup>11</sup> / <sub>32</sub>	1 <sup>15</sup> / <sub>64</sub>
AL 250 NTN*	ASL 250 NTN*	250, 4/0		250-300	4/0 (6/1)		TX, 76, 249, 840, 11A	1 <sup>15</sup> / <sub>16</sub>	6	3 <sup>11</sup> / <sub>32</sub>	1 <sup>15</sup> / <sub>64</sub>
AL 300 NTN*	ASL 300 NTN*	300, 266.8		350	266.8 (18/1)		TH, 87H, 251, 470, 1, 12A	2 <sup>3</sup> / <sub>16</sub>	6 <sup>3</sup> / <sub>16</sub>	3 <sup>3</sup> / <sub>16</sub>	1 <sup>11</sup> / <sub>32</sub>
AL 350 NTN*	ASL 350 NTN*	350, 336.4		-	266.8 (26/7), 336.4 (18/1)		96, 299, 655, 1 <sup>1</sup> / <sub>8</sub> -1, 705, 13A	2 <sup>3</sup> / <sub>16</sub>	6 <sup>3</sup> / <sub>16</sub>	3 <sup>11</sup> / <sub>16</sub>	1 <sup>3</sup> / <sub>4</sub>
AL 336 NSCTN	-	397.5-400			336.4 (26/7), 397.5 (18/1)		1 <sup>1</sup> / <sub>4</sub> , 99H, 317, 20AH	4 <sup>3</sup> / <sub>16</sub>	9	3 <sup>11</sup> / <sub>16</sub>	1 <sup>21</sup> / <sub>32</sub>
AL 400 NTN*	ASL 400 NTN*	400, 397.5					96, 472, 655, 1 <sup>1</sup> / <sub>8</sub> -1, 1 <sup>1</sup> / <sub>8</sub> -2, 705, 316, 13A	2 <sup>7</sup> / <sub>16</sub>	7 <sup>5</sup> / <sub>16</sub>	3 <sup>3</sup> / <sub>16</sub>	1 <sup>3</sup> / <sub>4</sub>
AL 500 NTN*	ASL 500 NTN*	500, 477		500-600	397.5 (26/7), 477 (18/1)		106A, 300, 317, 1 <sup>1</sup> / <sub>8</sub> , 14A, 15A	2 <sup>15</sup> / <sub>16</sub>	8 <sup>3</sup> / <sub>4</sub>	3 <sup>3</sup> / <sub>16</sub>	1 <sup>3</sup> / <sub>4</sub>
AL 500 N 608 TN	-			600			608	3 <sup>3</sup> / <sub>8</sub>	8 <sup>3</sup> / <sub>4</sub>	3 <sup>3</sup> / <sub>16</sub>	1 <sup>3</sup> / <sub>4</sub>
AL 600 NTN*	ASL 600 NTN*	600, 550		-	477 (26/7), 556.5 (18/1)		1 <sup>1</sup> / <sub>8</sub> , 115H, 786, 936, 473	2 <sup>15</sup> / <sub>16</sub>	7 <sup>3</sup> / <sub>4</sub>	3 <sup>3</sup> / <sub>8</sub>	1 <sup>3</sup> / <sub>4</sub> *
AL 700 N 608TN	-	700, 600		700-795			125H, 608	3 <sup>3</sup> / <sub>8</sub>	7 <sup>3</sup> / <sub>8</sub>	3 <sup>1</sup> / <sub>2</sub>	1 <sup>3</sup> / <sub>4</sub>
AL 750 NTN*	ASL 750 NTN*	750, 700		-	636 (26/7)		140H, 301, 342, 1 <sup>1</sup> / <sub>2</sub>	3 <sup>3</sup> / <sub>16</sub>	8 <sup>3</sup> / <sub>4</sub>	3 <sup>3</sup> / <sub>4</sub>	1 <sup>3</sup> / <sub>4</sub> *
AL 750 N 608*	ASL 750 N 608*	750, 700					125H, 608	3 <sup>3</sup> / <sub>8</sub>	8 <sup>3</sup> / <sub>4</sub>	3 <sup>3</sup> / <sub>8</sub>	1 <sup>3</sup> / <sub>4</sub>
AL 800 NTN*	ASL 800 NTN*	800, 795			663 (30/19), 715.5 (54/7)		140H, 474, 342, 724, 1 <sup>1</sup> / <sub>2</sub>	3 <sup>11</sup> / <sub>32</sub>	8 <sup>5</sup> / <sub>16</sub>	3 <sup>5</sup> / <sub>8</sub>	1 <sup>3</sup> / <sub>4</sub> *
AL 800 N 608 TN	-	800, 700			636 (30/19), 715.5 (54/7)		608	3 <sup>3</sup> / <sub>8</sub>	8 <sup>3</sup> / <sub>4</sub>	3 <sup>5</sup> / <sub>8</sub>	1 <sup>3</sup> / <sub>4</sub>
AL 954 NMS	-	-			954 (54/7)		161, 292, 302, 319, 1 <sup>3</sup> / <sub>4</sub>	4 <sup>11</sup> / <sub>16</sub>	9 <sup>3</sup> / <sub>8</sub>	1 <sup>7</sup> / <sub>8</sub>	1 <sup>3</sup> / <sub>4</sub>
AL 1000 NTN*	ASL 1000 NTN*	1000, 954			795 (26/7, 30/19), 954 (45/7)			4 <sup>3</sup> / <sub>16</sub>	8 <sup>3</sup> / <sub>16</sub>	3 <sup>5</sup> / <sub>8</sub>	2- <sup>7</sup> / <sub>16</sub>
AL 1000 SSNTN	ASL 1000 SSNTN	1000			-			4 <sup>3</sup> / <sub>16</sub>	9 <sup>7</sup> / <sub>8</sub>	3 <sup>5</sup> / <sub>8</sub>	2 <sup>7</sup> / <sub>16</sub>
AL 1000 NMS	-							4 <sup>11</sup> / <sub>16</sub>	9 <sup>1</sup> / <sub>2</sub>	3 <sup>5</sup> / <sub>8</sub>	1 <sup>3</sup> / <sub>4</sub>
AL 1250 NTN	ASL 1250 NTN	1200-1300			1113 (45/7), 1192.5 (45/7)		161, 727, 352	4 <sup>11</sup> / <sub>16</sub>	9 <sup>11</sup> / <sub>16</sub>	3 <sup>5</sup> / <sub>8</sub>	2 <sup>21</sup> / <sub>32</sub>
AL 1750 NTN	ASL 1750 NTN	1750					214, 735, 225	5 <sup>1</sup> / <sub>2</sub>	10 <sup>7</sup> / <sub>8</sub>	3 <sup>5</sup> / <sub>8</sub>	3 <sup>13</sup> / <sub>32</sub>
AL 2000 NTN	ASL 2000 NTN	2000					479	6 <sup>1</sup> / <sub>16</sub>	11 <sup>15</sup> / <sub>16</sub>	3 <sup>5</sup> / <sub>8</sub>	3 <sup>13</sup> / <sub>32</sub>

### Diagrams

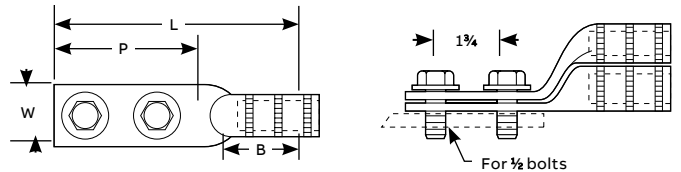

\* UL listed.

For two-hole lugs that are not tin-plated, see page 33. For straight lugs with tapered ends used in high-voltage applications, please consult your ABB representative.

# Aluminum lugs

## Four-hole NEMA lugs



AL 1000-4N

### General-purpose lugs for aluminum and copper terminations

- Use with aluminum and copper conductors
- Provides high strength and high conductivity
- Prevents oxidation and keeps out moisture
- Easy identification

### Four-hole NEMA lugs

Cat. no.	Conductor range (AWG or kcmil)		Installing dies	Dimensions (in.)					
	Concentric	ACSR		B	N	C	W	P	L
AL 1000-4N	1000	-	161, 302, 292, 319, 1¾	4 <sup>9</sup> / <sub>16</sub>	1¾	5 <sup>5</sup> / <sub>16</sub>	3	4	10
AL 14136 X	1033.5-1300	900-1113	161, 727, 352	7 <sup>11</sup> / <sub>16</sub>		5 <sup>5</sup> / <sub>16</sub>	3	4¼	13¾
AL 1033-4N	-	1033.5 (54/7)	34 AH	6 <sup>3</sup> / <sub>16</sub>		5 <sup>5</sup> / <sub>16</sub>	3 <sup>3</sup> / <sub>8</sub>	3 <sup>11</sup> / <sub>16</sub>	12¾
AL 1250-4N	1250	-	161, 727, 352	4 <sup>5</sup> / <sub>16</sub>		5 <sup>5</sup> / <sub>16</sub>	3	3 <sup>9</sup> / <sub>16</sub>	10
AL 1272-4N	1272	-	161, 727, 352, 579	6 <sup>7</sup> / <sub>16</sub>		5 <sup>5</sup> / <sub>16</sub>	3	3 <sup>5</sup> / <sub>8</sub>	11¼
AL 1590-4N	1590	1272 (45/7)	728, 38AH, 189	8 <sup>7</sup> / <sub>16</sub>		5 <sup>5</sup> / <sub>16</sub>	3	3 <sup>5</sup> / <sub>8</sub>	13½
AL 1750-4N	1750	-	214, 735, 40AH, 225	6 <sup>11</sup> / <sub>16</sub>		7 <sup>1</sup> / <sub>16</sub>	3½	3¾	12 <sup>1</sup> / <sub>8</sub>
AL 2000-4N	1700-2000	1510.5-1590		6 <sup>11</sup> / <sub>16</sub>		7 <sup>1</sup> / <sub>16</sub>	3½	3¾	12 <sup>1</sup> / <sub>8</sub>
AL 2300-4N	2250-2300	2167 (72/7)	44AH	11 <sup>3</sup> / <sub>4</sub>		1 <sup>1</sup> / <sub>8</sub>	4	4½	18½
AL 2500-4N	2500	2156-2167	214	9 <sup>5</sup> / <sub>8</sub>		1 <sup>1</sup> / <sub>8</sub>	3½	4	15 <sup>3</sup> / <sub>8</sub>

Diagram

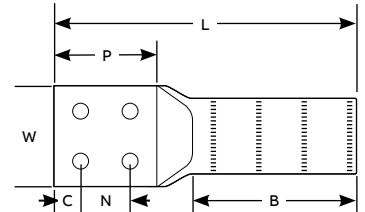

For tin-plated option, add "-TN" suffix to the catalogue number.

# Aluminum lugs

## One-hole NEMA lugs – Common die series



SA 3/0-48

**Designed for general applications and for installation on Homac 125 Series insulated buses**

- Lessens your die inventory
- Double terminal capacity of transformer spades and buses to save money
- Use with aluminum and copper conductors
- Provides high strength and high conductivity
- Easy identification
- Meets or exceeds ANSI C119.4 specifications

### One-hole NEMA lugs – Common die series

Straight lug Cat. no.	Stacking lug Cat. no.	Conductor – Al or Cu					Installing dies	Dimensions (in.)				
		Concentric	Compressed	Compact	Solid	ACSR		B	H	L	P	W
SA 12-48	-	#12	-	-	#12	-	TU, 52, BG, 243, 5/8, CSA 22	23/32	-	2 9/16	1 1/4	7/8
SA 10-48	-	-	-	-	-	-	-	23/32	-	2 9/16	1 1/4	7/8
SA 8-48	-	#8	-	-	#6	-	-	1 7/16	-	3 1/8	1 5/16	7/8
SA 6-48	-	#6	#6	#4	#4	#6	-	1 7/16	-	3 1/8	1 5/16	7/8
SA 4-48	-	#4	#4	-	#2	#4	-	1 7/16	-	3 1/8	1 5/16	7/8
SA 3-48	-	#2	#2	#1, #2	#1	-	-	1 7/16	-	3 1/8	1 5/16	7/8
SA 2-48	SASL 2-48	#1, #2	#1	#1	1/0	#2	-	1 7/16	1 1/2	3 1/8	1 5/16	7/8
SA 386-48	-	#1	1/0	1/0	-	-	-	1 7/16	-	3 1/8	1 5/16	7/8
SA 1/0-48	SASL 1/0-48	1/0	2/0	2/0	-	1/0	-	1 7/16	1 1/2	3 1/8	1 5/16	7/8
SA 2/0-48	SASL 2/0-48	2/0	3/0	3/0	3/0	2/0 (6/1)	TX, 76, 249, 840, 845, 11A, CSA 24	1 25/64	1 3/4	3 21/64	1 11/32	1 5/32
SA 3/0-48	SASL 3/0-48	3/0	4/0	4/0	-	3/0	-	1 25/64	1 3/4	3 21/64	1 11/32	1 5/32
SA 4/0-48	SASL 4/0-48	4/0, 250	4/0, 250	250, 300	-	4/0	-	1 25/64	1 3/8	3 21/64	1 11/32	1 5/32
SA 300-48	-	300	300	350	-	266.8 (18/1)	96, 299, 655, 321, 316, 13A, 1 (1/8-1), 472, CSA 28	1 19/32	-	3 5/8	1 11/32	1 1/4
SA 350-48	-	336.4-350	350	400	-	266.8 (26/7), 336.4 (18/1)	-	1 19/32	-	3 5/8	1 11/32	1 1/4
SA 400-48	-	336.4-400	400	500	-	336.4 (18/1), 397.5 (18/1)	-	1 19/32	-	3 5/8	1 11/32	1 1/4

### Diagrams

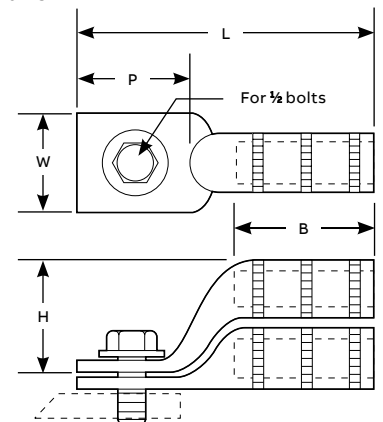

For tin-plated option, add "-TN" suffix to the catalogue number.

To order a stud size not specified with a terminal lug on this page, change the last two digits from "48" (designating a 1/2" stud) to "38" (for a 3/8" stud).

# Aluminum lugs

## Two-hole NEMA – Common die series



**Designed for general applications and for installation on Homac 125-N Series insulated buses**

- Lessens your die inventory
- Double terminal capacity of transformer spades and buses to save money
- Use with aluminum and copper conductors
- Provides high strength and high conductivity
- Prevents oxidation and keeps out moisture
- Easy identification
- Meets or exceeds ANSI C119.4 specifications

### Two-hole NEMA – Common die series

Straight lug Cat. no.	Stacking lug Cat. no.	Conductor – Al or Cu					Installing dies	Dimensions (in.)				
		Concentric	Compressed	Compact	Solid	ACSR		B	H	L	P	W
SA 8 N	-	#8	-	-	#6	-	TU, 52, BG, 243, 5%, CSA 22	1 <sup>15</sup> / <sub>16</sub>	-	5 <sup>1</sup> / <sub>8</sub>	3 <sup>3</sup> / <sub>16</sub>	7 <sup>1</sup> / <sub>8</sub>
SA 6 N	SASL 6 N	#6	#6	#4	#4	#6		1 <sup>15</sup> / <sub>16</sub>	1 <sup>1</sup> / <sub>2</sub>	5 <sup>1</sup> / <sub>8</sub>	3 <sup>3</sup> / <sub>16</sub>	7 <sup>1</sup> / <sub>8</sub>
SA 4 N	-	#4	#4	#4	#2	#4		1 <sup>15</sup> / <sub>16</sub>	-	5 <sup>1</sup> / <sub>8</sub>	3 <sup>3</sup> / <sub>16</sub>	7 <sup>1</sup> / <sub>8</sub>
SA 3 N		#2	#2	#1, #2	#1	-		1 <sup>15</sup> / <sub>16</sub>		5 <sup>1</sup> / <sub>8</sub>	3 <sup>3</sup> / <sub>16</sub>	7 <sup>1</sup> / <sub>8</sub>
SA 2 N		#1, #2	#1	#1	1/0	#2		1 <sup>1</sup> / <sub>2</sub>		5 <sup>3</sup> / <sub>16</sub>	3 <sup>3</sup> / <sub>16</sub>	1
SA 386N		#1, 1/0	#1, 1/0	1/0	-	#1		2 <sup>7</sup> / <sub>32</sub>		5 <sup>1</sup> / <sub>2</sub>	3	7 <sup>1</sup> / <sub>8</sub>
AL 1/0 N	SASL 1/0 N	1/0	1/0	2/0	2/0	1/0		1 <sup>1</sup> / <sub>2</sub>	1 <sup>1</sup> / <sub>2</sub>	5 <sup>1</sup> / <sub>4</sub>	3 <sup>3</sup> / <sub>16</sub>	7 <sup>1</sup> / <sub>8</sub>
SA 2/0 N	SASL 2/0 N	2/0	2/0	3/0	3/0	2/0 (6/1)	TX, 76, 249, 840, 845, 11A, CSA 24	1 <sup>15</sup> / <sub>16</sub>	1 <sup>3</sup> / <sub>4</sub>	6	3 <sup>3</sup> / <sub>16</sub>	1 <sup>1</sup> / <sub>4</sub>
SA 3/0 N	SASL 3/0 N	3/0	4/0	4/0	-	3/0		1 <sup>15</sup> / <sub>16</sub>	1 <sup>3</sup> / <sub>4</sub>	6	3 <sup>3</sup> / <sub>16</sub>	1 <sup>5</sup> / <sub>32</sub>
SA 4/0 N	SASL 4/0 N	4/0, 250	4/0, 250	250, 300		4/0		1 <sup>15</sup> / <sub>16</sub>	1 <sup>3</sup> / <sub>16</sub>	6	3 <sup>3</sup> / <sub>16</sub>	1 <sup>7</sup> / <sub>32</sub>
SA 300 N	-	300	300	350		266.8 (18/1)	96, 299, 655, 705,	2 <sup>1</sup> / <sub>16</sub>	-	6 <sup>1</sup> / <sub>4</sub>	3	1 <sup>1</sup> / <sub>4</sub>
SA 350 N		336.4-350	350	400		266.8 (26/7), 336.4 (18/1)	321, 316, 13A, 1 (3/8-1), 472, CSA 28	2 <sup>3</sup> / <sub>16</sub>		6 <sup>1</sup> / <sub>4</sub>	3	1 <sup>1</sup> / <sub>4</sub>
SA 400 N		336.4-400	400	500		336.4 (18/1), 397.5 (18/1)		2 <sup>7</sup> / <sub>16</sub>		6 <sup>3</sup> / <sub>8</sub>	3	1 <sup>1</sup> / <sub>4</sub>

### Diagrams

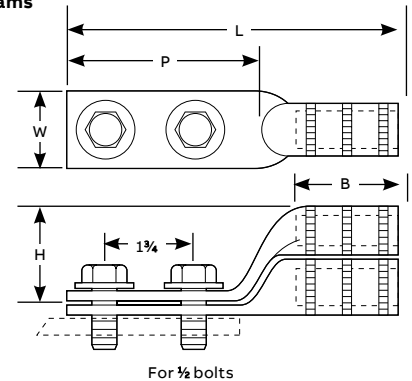

For tin-plated option, add "-TN" suffix to the catalogue number.



# Aluminum lugs

## Meter socket lugs – 840 Common die series



SAKM 250-48

**Just one die installs the entire conductor range for meter pan and general applications**

- Lessens your die inventory
- Provides high strength and high conductivity
- Use with aluminum and copper conductors
- Prevents oxidation
- Easy identification
- Meets or exceeds ANSI C119.4 specifications

### Meter socket lugs – 840 Common die series

½ bolt Cat. no.	¾ bolt Cat. no.	Conductors – Al or Cu				Installing dies
		Concentric	Compressed	Compact	Solid	
SAKM 6-48	SAKM 6-38	#6	#6	#6	–	840, 845, TX, 76, 249, 11A
SAKM 4-48	SAKM 4-38	#4	#4	#4	–	840, 845, TX, 76, 249, 11A
SAKM 2-48	SAKM 2-38	#2	#2	#2, #1	#1	840, 845, TX, 76, 249, 11A
SAKM1-48	SAKM 1-38	#1	#1	1/0	1/0	840, 845, TX, 76, 249, 11A
SAKM 1/0-48	SAKM 1/0-38	1/0	1/0	2/0	2/0	840, 845, TX, 76, 249, 11A
SAKM 2/0-48	SAKM 2/0-38	2/0	2/0	3/0	3/0	840, 845, TX, 76, 249, 11A
SAKM 3/0-48	SAKM 3/0-38	3/0	3/0	4/0	–	840, 845, TX, 76, 249, 11A
SAKM 4/0-48	SAKM 4/0-38	4/0	4/0	250	–	840, 845, TX, 76, 249, 11A
SAKM 250-48*	SAKM 250-38*	250	250	300	–	840, 845, TX, 76, 249, 11A
SAKM 300-48*	SAKM 300-38*	300	300	350	–	840, 845, TX, 76, 249, 11A
SAKM 350-48*	SAKM 350-38*	350	350	–	–	840, 845, TX, 76, 249, 11A

### Diagrams

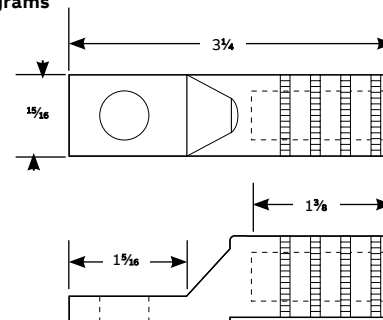

\* For aluminum conductors only.  
For tin-plated option, add "-TN" suffix to the catalogue number.

# Aluminum lugs

## Tin-plated meter socket lugs – Star hole



MSL 350

### Dual-rated, corrosion-resistant lugs available with star holes

- Provides high strength and high conductivity
- Use with aluminum and copper conductors
- Resistant to corrosion
- Prevents oxidation and keeps out moisture

### Tin-plated meter socket lugs – Star hole

Cat. no.	Conductor size	Installing dies	Dimensions (in.)			
			W	L	P	B
MSL 4	#4 str. cpt.	840, 845, TX, 76, 249, 11A	$\frac{15}{16}$	$3\frac{1}{4}$	$1\frac{5}{16}$	$1\frac{3}{8}$
MSL 2	#2 str. cpt.	840, 845, TX, 76, 249, 11A	$\frac{15}{16}$	$3\frac{1}{4}$	$1\frac{5}{16}$	$1\frac{3}{8}$
MSL 1/0	1/0 str. cpt.	840, 845, TX, 76, 249, 11A	$\frac{15}{16}$	$3\frac{1}{4}$	$1\frac{5}{16}$	$1\frac{3}{8}$
MSL 2/0	2/0 str. cpt.	840, 845, TX, 76, 249, 11A	$\frac{15}{16}$	$3\frac{1}{4}$	$1\frac{5}{16}$	$1\frac{3}{8}$
MSL 3/0	3/0 str. cpt.	840, 845, TX, 76, 249, 11A	$\frac{15}{16}$	$3\frac{1}{4}$	$1\frac{5}{16}$	$1\frac{3}{8}$
MSL 4/0	4/0 str. cpt.	840, 845, TX, 76, 249, 11A	$\frac{15}{16}$	$3\frac{1}{4}$	$1\frac{5}{16}$	$1\frac{3}{8}$
MSL 250	250 str. cpt.	840, 845, TX, 76, 249, 11A	$\frac{15}{16}$	$3\frac{1}{4}$	$1\frac{5}{16}$	$1\frac{3}{8}$
MSL 300	300 str. cpt.	840, 845, TX, 76, 249, 11A	$\frac{15}{16}$	$3\frac{1}{4}$	$1\frac{5}{16}$	$1\frac{3}{8}$
MSL 350	350 str. cpt.	840, 845, TX, 76, 249, 11A	$\frac{15}{16}$	$3\frac{1}{4}$	$1\frac{5}{16}$	$1\frac{3}{8}$
MSL 500	500 str.	106A, 300, 317, $1\frac{1}{16}$ , 15A	$1\frac{3}{4}$	$4\frac{7}{8}$	$1\frac{3}{4}$	$3\frac{3}{16}$

### Diagrams

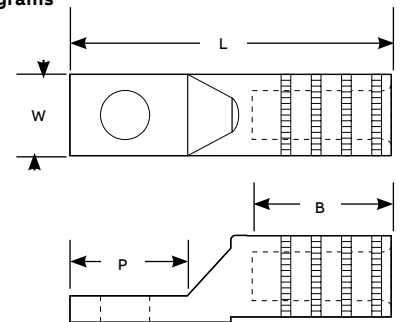

## Aluminum lugs

Two-hole NEMA lugs – Common die series



SAB 500 N

### Lugs designed for general-purpose substation and switchyard equipment use

- Lessens your die inventory
- Use with aluminum and copper conductors
- Provides high strength and high conductivity
- Prevents oxidation and keeps out moisture
- Easy identification

### Two-hole NEMA lugs — Common die series

Cat. no.	Conductor range (AWG or kcmil)					Installing dies	Dimensions (in.)		
	Concentric	Compressed	Compact	ACSR			L	W	B
SAK 4 N	#4	-	-	-		TX, 76, 249, 840, 11A	5 <sup>3</sup> / <sub>4</sub>	1 <sup>1</sup> / <sub>4</sub>	2
SAK 2 N	#1, #2	-	-	#2		TX, 76, 249, 840, 11A	5 <sup>3</sup> / <sub>4</sub>	1 <sup>1</sup> / <sub>4</sub>	2
SAK 1/0 N	1/0	2/0	2/0	1/0		TX, 76, 249, 840, 11A	5 <sup>3</sup> / <sub>4</sub>	1 <sup>1</sup> / <sub>4</sub>	2
SAK 300 N	-	-	350	-		TX, 76, 249, 840, 11A	6 <sup>1</sup> / <sub>4</sub>	1 <sup>1</sup> / <sub>4</sub>	2 <sup>1</sup> / <sub>16</sub>
SAK 350 N	350	-	-	-		TX, 76, 249, 840, 11A	6 <sup>1</sup> / <sub>4</sub>	1 <sup>1</sup> / <sub>4</sub>	2 <sup>1</sup> / <sub>16</sub>
SAB 3/0 N	3/0	-	-	3/0		96, 299, 655, 1 (1/8-1), 13A	6 <sup>3</sup> / <sub>8</sub>	1 <sup>1</sup> / <sub>2</sub>	2 <sup>3</sup> / <sub>4</sub>
SAB 4/0 N	4/0, 250	-	-	4/0		96, 299, 655, 1 (1/8-1), 13A	6 <sup>3</sup> / <sub>8</sub>	1 <sup>1</sup> / <sub>2</sub>	2 <sup>3</sup> / <sub>4</sub>
SAB 250 N	266.8-300	-	-	266.8 (18/1)		96, 299, 655, 1 (1/8-1), 13A	6 <sup>3</sup> / <sub>8</sub>	1 <sup>1</sup> / <sub>2</sub>	2 <sup>3</sup> / <sub>4</sub>
SAB 500 N	477-500	-	600	397.5 (26/7, 30/7), 477 (18/1)		96, 299, 655, 1 (1/8-1), 13A	6 <sup>3</sup> / <sub>8</sub>	1 <sup>1</sup> / <sub>4</sub>	2 <sup>3</sup> / <sub>4</sub>
SAM 400 N	397.5-400	-	500	336.4 (30/7), 397.5 (18/1)		106, 300, 317, 1 <sup>1</sup> / <sub>16</sub> , 14A, 15A	8 <sup>29</sup> / <sub>64</sub>	1 <sup>3</sup> / <sub>4</sub>	3 <sup>13</sup> / <sub>16</sub>
SAM 556 N	500-556	-	-	477 (26/7), 556.5 (18/1)		106, 300, 317, 1 <sup>1</sup> / <sub>16</sub> , 14A, 15A	8 <sup>3</sup> / <sub>8</sub>	1 <sup>3</sup> / <sub>4</sub>	3 <sup>27</sup> / <sub>32</sub>
SAM 600 N	600	-	-	-		106, 300, 317, 1 <sup>1</sup> / <sub>16</sub> , 14A, 15A	8 <sup>3</sup> / <sub>8</sub>	1 <sup>3</sup> / <sub>4</sub>	3 <sup>27</sup> / <sub>32</sub>

### Diagrams

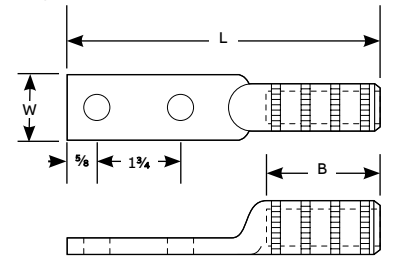

# Aluminum lugs

## Four-hole NEMA lugs – Common die series



MSL 350

### Durable four-hole lugs for general-purpose substation and switchyard equipment use

- Lessens your die inventory
- Use with aluminum and copper conductors
- Provides high strength and high conductivity
- Prevents oxidation and keeps out moisture
- Easy identification

### Four-hole NEMA lugs – Common die series

Cat. no.	Conductor range (AWG or kcmil)			Installing dies	Dimensions (in.)	
	Concentric	Compact	ACSR		L	B
SAM 3/0-4N*	3/0	–	–	1 <sup>5</sup> / <sub>16</sub> , 300, 14A, 106, 317	8 <sup>1</sup> / <sub>8</sub>	3 <sup>3</sup> / <sub>16</sub>
SAM 4/0-4N*	4/0	–	4/0	1 <sup>5</sup> / <sub>16</sub> , 300, 14A, 106, 317	8 <sup>1</sup> / <sub>8</sub>	3 <sup>3</sup> / <sub>16</sub>
SAM 250-4N*	250	–	–	1 <sup>5</sup> / <sub>16</sub> , 300, 14A, 106, 317	8 <sup>1</sup> / <sub>8</sub>	3 <sup>3</sup> / <sub>16</sub>
SAM 300-4N*	300	–	–	1 <sup>5</sup> / <sub>16</sub> , 300, 14A, 106, 317	7 <sup>7</sup> / <sub>8</sub>	3 <sup>21</sup> / <sub>64</sub>
SAM 350-4N*	336.4-350	–	266.8 (26/7), 336.4 (18/1)	1 <sup>5</sup> / <sub>16</sub> , 300, 14A, 106, 317	7 <sup>7</sup> / <sub>8</sub>	3 <sup>21</sup> / <sub>64</sub>
SAM 400-4N*	397.5-400	–	336.4 (30/7), 397.5 (18/1)	1 <sup>5</sup> / <sub>16</sub> , 300, 14A, 106, 317	7 <sup>7</sup> / <sub>8</sub>	3 <sup>21</sup> / <sub>64</sub>
SAM 500-4N*	500	–	–	1 <sup>5</sup> / <sub>16</sub> , 300, 14A, 106, 317	8 <sup>1</sup> / <sub>4</sub>	3 <sup>3</sup> / <sub>16</sub>
SAM 600-4N*	556.5-600	–	–	1 <sup>5</sup> / <sub>16</sub> , 300, 14A, 106, 317	8 <sup>1</sup> / <sub>4</sub>	3 <sup>3</sup> / <sub>16</sub>
SAL 500-4N*	500	–	477 (18/1)	140H, 301, 342, 1 <sup>1</sup> / <sub>2</sub>	8 <sup>1</sup> / <sub>4</sub>	3 <sup>3</sup> / <sub>8</sub>
SAL 600-4N	600	–	477 (24/7, 30/7)	140H, 301, 342, 1 <sup>1</sup> / <sub>2</sub>	7 <sup>7</sup> / <sub>8</sub>	3 <sup>3</sup> / <sub>8</sub>
SAL 650-4N	600, 636, 650	–	556.5 (24/7, 26/7)	140H, 301, 342, 1 <sup>1</sup> / <sub>2</sub>	7 <sup>7</sup> / <sub>8</sub>	3 <sup>3</sup> / <sub>8</sub>
SAL 750-4N	700-750	–	636 (26/7)	140H, 301, 342, 1 <sup>1</sup> / <sub>2</sub>	9	4 <sup>7</sup> / <sub>32</sub>
SAL 800-4N	700-800	954	636 (26/7)	140H, 301, 342, 1 <sup>1</sup> / <sub>2</sub>	8 <sup>3</sup> / <sub>4</sub>	4 <sup>3</sup> / <sub>32</sub>
SAL 1000-4N	1,000	1,000	795 (30/19), 874 (54/7)	140H, 301, 342, 1 <sup>1</sup> / <sub>2</sub>	8 <sup>3</sup> / <sub>4</sub>	4 <sup>5</sup> / <sub>32</sub>
SAL 1033-4N	1,033	–	900 (54/7), 954 (45/7)	140H, 301, 342, 1 <sup>1</sup> / <sub>2</sub>	9	4 <sup>5</sup> / <sub>32</sub>

### Diagrams

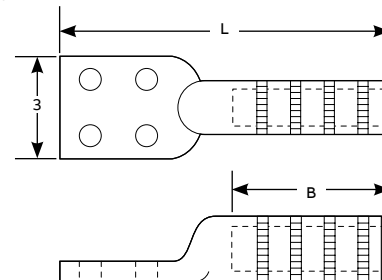

\* Designates 2-piece welded design.

## Aluminum lugs

### Shrouded one-hole lugs – Common die series



RSG 1/0-48



RSK 2-48



Style 2

Style 1

#### If you need rain protection, these lugs have you covered

- Prevents rainwater from entering cable
- Lessens your die inventory
- Provides high strength and high conductivity
- Use with aluminum and copper conductors
- Prevents oxidation
- Easy identification
- Meets or exceeds ANSI C119.4 specifications

#### Shrouded one-hole lugs – Common die series

Cat. no.	Conductor size (AWG or kcmil)		Shroud I.D.	Comp. die size	L	Style
	Concentric	Compact				
<b>3/8" Compression die series</b>						
RSG 6-48	#6	–	0.400	3/8, 8A, 243, TU, 52, BG	3 3/8	2
RSG 4-48	#4	#4	0.450	3/8, 8A, 243, TU, 52, BG	3 3/8	2
RSG 2-48	#2, #1	#1	0.635	3/8, 8A, 243, TU, 52, BG	3 3/8	1
RSG 1/0-48	1/0	2/0	0.640	3/8, 8A, 243, TU, 52, BG	3 3/8	1
<b>840 Compression die series</b>						
RSK 1/0-48	1/0	2/0	0.640	840, 11A, 249, 76, TX	3 3/4	2
RSK 2/0-48	2/0	3/0	0.750	840, 11A, 249, 76, TX	3 3/4	2
RSK 3/0-48	3/0	4/0	0.750	840, 11A, 249, 76, TX	3 3/4	2
RSK 4/0-48	4/0	4/0	0.750	840, 11A, 249, 76, TX	3 3/4	2
RSK 250-48	4/0-250	350	0.812	840, 11A, 249, 76, TX	3 3/4	2
RSK 350-48	350	–	0.927	840, 11A, 249, 76, TX	4 7/16	1
<b>1 1/8" Compression die series</b>						
RSB 300-48	300	300	0.927	1 (3/8-1), 12A, 96, 299, 655	4 1/2	2
RSB 350-48	350	300	0.927	1 (3/8-1), 12A, 96, 299, 655	4 1/2	2

Diagram

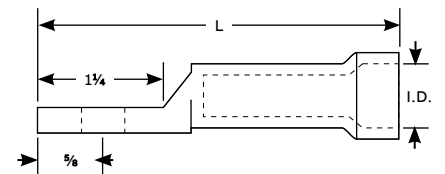

For tin-plated option, add "-TN" suffix to the catalogue number.

To order a terminal lug for a 3/8" stud, change a catalogue number's "-48" suffix (designating a 1/2-in. stud) to a "-38" suffix.

To order with hardware as kits, add "-TMH" suffix to the catalogue number.

# Aluminum lugs

Tin-plated one-hole lugs



**For application in meter pans and in other metal-enclosed gear to convenience wiring where clearances are minimal**

- Assures high strength and high conductivity
- Provides resistance against corrosion
- Use with aluminum and copper conductors
- Prevents oxidation
- Easy identification
- Meets or exceeds ANSI C119.4 specifications

**Tin-plated one-hole lugs**

Left-hand lug Cat. no.	Right-hand lug Cat. no.	Conductor size (AWG or kcmil)			Installing dies	Dimensions (in.)		
		Concentric	Compressed	Compact		B	L	W
AL 1/0-48 LTN	AL 1/0-48 RTN	1/0	1/0	2/0	5/8, BG, TU	1 3/8	2 11/16	1 3/8
AL 2/0-48 LTN	AL 2/0-48 RTN	2/0	2/0	-	1 1/8, 297, TW-TY	1 3/8	2 11/16	1 3/8
AL 3/0-48 LTN	AL 3/0-48 RTN	3/0	3/0	-	737, 467	1 3/8	3 3/4	1 3/8
AL 4/0-48 LTN	AL 4/0-48 RTN	4/0	4/0	-	840, 298, TX	1 1/2	4	1 3/4
AL 250-48 LTN	AL 250-48 RTN	250	250	300	840, 324, TX	1 5/8	4 1/8	1 3/4
AL 300-48 LTN	AL 300-48 RTN	300	300	350	1, 470, TH	1 5/8	4 3/8	1 1/2
AL 350-48 LTN	AL 350-48 RTN	350	350	350	1 (1/8-1), 299, 96	1 5/8	4 3/8	1 1/2
AL 400-48 LTN	AL 400-48 RTN	400	400	400	1 1/8, 472, 96	2 1/2	5 3/4	1 1/2
AL 500-48 LTN	AL 500-48 RTN	500	500	500	1 1/16, 300, 106A	2 1/2	5 3/4	1 1/2
AL 750-48 LTN	AL 750-48 RTN	700-750	800	800	1 1/2, 301, 140H	3 1/4	6 3/8	3 1/2

Diagram

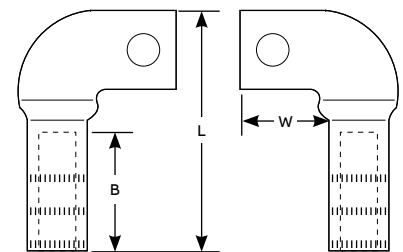

For NEMA-drilled lugs, substitute a "-NLTN" suffix for a "-48 x TN" suffix to the catalogue number. Thus AL 350-48 RTN becomes AL 350-NLTN. NEMA drilling is 2 9/16" holes on 1 3/4" centers.

## Aluminum lugs

Multi-range die-less lugs and pin terminals



AL 4/0 NTN

### Save yourself a die job with these multi-range lugs

- Assures high strength and high conductivity
- Provides resistance against corrosion
- Use with aluminum and copper conductors
- Prevents oxidation
- Easy identification

### Multi-range die-less lugs

Cat. no.	Conductor range (AWG or kcmil) alum. or copper	Tool	Figure	Bolt size	Dimensions (in.)		
					B	L	P
AL 1/0-48 TN	#6 str.-1/0 str.	VC 5/VC 6	1	1/2	1 3/8	3 3/16	1 5/16
AL 1/0 NTN	#6 str.-1/0 str.	VC 5/VC 6	2	1/2	1 3/8	5 1/4	3 1/4
ASL 1/0 NTN	#6 str.-1/0 str.	VC 5/VC 6	3	1/2	1 3/8	5 1/4	3
AL 4/0-48 TN	#2 str.-4/0 str.	VC 5/VC 6	1	1/2	1 7/16	3 3/16	1 3/8
AL 4/0 NTN	#2 str.-4/0 str.	VC 5/VC 6	2	1/2	2	6	3 3/16
ASL 4/0 NTN	#2 str.-4/0 str.	VC 5/VC 6	3	1/2	2	6	3
AL 300-48 TN	1/0 str.-300	VC 6	1	1/2	2 1/4	4	1 5/16
AL 300 NTN	1/0 str.-300	VC 6	2	1/2	2 1/4	6 9/16	3 3/16
AASL 300 NTN	1/0 str.-300	VC 6	3	1/2	2 1/4	6 9/16	3
SAB 500-48 TN	4/0 str.-500	VC 6	1	1/2	2 1/2	4 9/16	1 1/2
SAB 500 NTN	4/0 str.-500	VC 6	2	1/2	2 1/4	6 3/8	3 1/8
AASL 500 NTN	4/0 str.-500	VC 6	3	1/2	2 1/2	6 7/8	2 7/8
AL 750 N 608 TN	4/0 str.-750	VC 8	2	1/2	3 3/4	8 3/4	3 3/8

### Diagrams

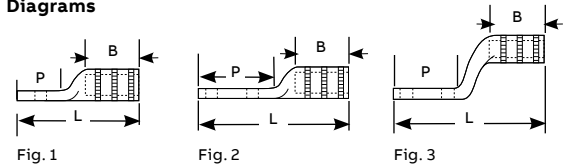

To order a stud size not specified here with a terminal lug, substitute a "-58" suffix (designating a 5/8" stud) for a "-48" suffix (designating a 1/2" stud) to the catalogue number.



### Pin terminals

### The pins you need for hassle-free terminations

- The high strength and conductivity of aluminum and the flexibility of copper
- No compatibility

Cat. no.	Conductor size (AWG or kcmil)	Decimal range		Tool	Cu pin	P
		Min. O.D.	Max. O.D.			
PTA 1/0	#10 sol.-1/0 ACSR	0.102	0.398	VC 5/6	#2	6
PTA 4/0	#4 sol.-4/0 ACSR	0.204	0.563	VC 5/6	2/0	6
PTA 350	2/0 str.-336.4 (18/1) ACSR	0.414	0.684	VC 6	4/0	6

### Diagram

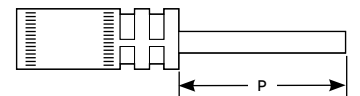

For tin-plated option, add "-TN" suffix to the catalogue number. For other pin lengths, please contact your ABB representative.

## Aluminum lugs

### Blackburn slotted-tang compression terminal lugs



Fig.1

Fig.2

Fig.3

Fig.4

#### Compress these lugs with standard tools and dies

- Use with a wide range of aluminum and copper conductors
- Prevents oxidation and keeps out moisture
- Boss fits the indent on the bus, preventing the lug from rotating
- The bus doesn't have to be removed
- RUS listed

#### Blackburn slotted-tang compression terminal lugs

Cat. no.	Color code	Conductor size (AWG or kcmil)			Fig. no.	Installation dies	
		Concentric	Compressed compact	Sol.		Mech. tool	Hydr. tool
LAC6	Blue	#6 str.	#6	#5	1	BY37, 840	B49EA, U-K840
LAC4	Orange	#4 str.	#4	#3.	1	BY37, 840	B49EA, U-K840
LAC3	Purple	#3 str.	-	#2	1	BY37, 840	B49EA, U-K840
LAC2	Red	#2 str.	#2	#1	1	BY37, 840	B49EA, U-K840
LAC1	White	#1 str.	#1	1/0	1	BY37, 840	B49EA, U-K840
LAC10	Yellow	1/0 str.	1/0	2/0	1	BY37, 840	B49EA, U-K840
LAC20	Grey	2/0 str.	2/0	3/0	2	BY37, 840U	B49EA, K840
LAC30	Black	3/0 str.	3/0	4/0	2	BY37, 840U	B49EA, K840
LAC40	Pink	4/0 str.	4/0	-	2	BY37, 840U	B49EA, K840
LAC42	Orange	#4 str.	#4	#3	2	BY37, 840U	B49EA, K840
LAC32	Purple	#3 str.	-	#2	2	BY37, 840U	B49EA, K840
LAC22	Red	#2 str.	#2	#1	2	BY37, 840U	B49EA, K840
LAC12	White	#1 str.	#1	1/0	2	BY37, 840U	B49EA, K840
LAC102	Yellow	1/0 str.	1/0	2/0	2	BY37, 840U	B49EA, K840
LAC202	Grey	2/0 str.	2/0	3/0	2	BY37, 840U	B49EA, K840
LAC302	Black	3/0 str.	3/0	4/0	2	BY37, 840U	B49EA, K840
LAC402	Pink	4/0 str.	4/0	-	2	BY37, 840U	B49EA, K840
LAC25	Green	350, 266.6	250	-	3	-	B80EA, 1.1, 655
LAC35	Brown	300, 350	350	-	3	-	B80EA, 1.1, 655
LAC50	Aqua	400, 500	500	-	3	-	B80EA, 1.1, 655
LAC125	Green	250, 266.8	250	-	4	-	B80EA, 1.1, 655
LAC135	Brown	300, 350	350	-	4	-	B80EA, 1.1, 655
LAC150	Aqua	400, 500	500	-	4	-	B80EA, 1.1, 655



## Aluminum lugs

### Bi-metallic lugs



CPL 2-48



CPL 600 N

#### Corrosion-resistant one- and two-hole lugs for ACSR and aluminum conductors

- Provides high strength
- Provides high conductivity and corrosion resistance
- Prevents oxidation and keeps out moisture

#### Bi-metallic lugs

Cat. no.	Conductor size (AWG or kcmil)		
	ACSR	Al	Bolt size (in.)
<b>CPL series – One hole</b>			
CPL 4-48	#4	#4	½
CPL 2-48	#2	#2	½
CPL 1/0-48	1/0	1/0	½
CPL 4/0-48	4/0	4/0	½
<b>CPL-N series – Two hole</b>			
CPL 4 N	#4	#4	½
CPL 2 N	#2	#2	½
CPL 1/0 N	1/0	1/0	½
CPL 2/0 N	2/0	2/0	½
CPL 3/0 N	3/0	3/0	½
CPL 4/0 N	4/0	4/0-250	½
CPL 300 N	266.8	266.8-300	½
CPL 350 N	336.4	336.4-350	½
CPL 477 N	397.5	396.5-477	½
CPL 556 N	477	500-556.5	½
CPL 600 N	556.5	600	½
CPL 800 N	605-666.6	715.5-800	½
CPL 1000 N	715.5-874.5	874.5-1,000	½
CPL 1113 N	900-1113	1,033.5-1,113	½
CPL 2000 N	1,780-1,900	2,000	½