

---

A

# Elastimold®/Fisher Pierce®

Cable accessories



—

A

# **Elastimold/Fisher Pierce**

Cable accessories

---

# Table of contents

## Section A

<b>Ratings</b>	A4
<b>Standard interfaces</b>	A6
<b>200 A loadbreak</b>	A7
<b>200 A deadbreak</b>	A13
<b>600 series deadbreak</b>	A17
<b>600 series deadbreak – Cam-Op®</b>	A24
<b>600 series deadbreak –Stick-Op®</b>	A27
<b>600 series deadbreak – cable joints</b>	A31
<b>Molded multi-point junctions</b>	A34
<b>Power cable joints</b>	A38
<b>Cable terminations</b>	A41
<b>Shield adapters, sealing and grounding</b>	A44
<b>Equipment bushings</b>	A46
<b>How to specify size-sensitive products</b>	A47
<b>AEIC and ICEA cable insulation diameter</b>	A50
<b>WX size tables</b>	A54
<b>Shrink-Fit cable joints</b>	A56
<b>Ranger2™ terminations</b>	A60
<b>Faulted circuit indicators</b>	A67
<b>Underground distribution switchgear</b>	A77
<b>Molded fuse products</b>	A91
<b>Surge arresters</b>	A104
<b>Molded vacuum recloser</b>	A114

# Elastimold underground cable accessories

## Overview

Elastimold separable connectors, cable joints, cable terminators and other cable accessory products have been designed and tested per applicable portions of IEEE, ANSI and other industry standards including:

- IEEE 386 standard for separable connectors
- IEEE 404 standard for cable joints and splices
- IEEE 48 standard for cable terminations
- IEEE 592 standard for exposed semiconducting shields
- ANSI C119.4 standard for copper and aluminum conductor connectors
- AEIC CS8 standards for XLP and EPR insulated cables
- ICEA S-94-649-2004 and S-97-682-2000 standard for cables rated 5,000 – 46,000 V

### Cable joints and terminations ratings

Refer to the pages listed below for rating information:

- PCJ™ cable joints, page A38
- SFJ Shrink Fit cable joints, page A31
- Cable terminations, page A41

### Separable connector ratings

The following chart shows voltage and current ratings that apply to all separable connectors, including 200 A loadbreak, 200 A deadbreak and 600/900 A series deadbreak products. The next chart shows switching and fault close ratings, which only apply to 200 A loadbreak connectors.

### Voltage and current ratings

	15 kV class ratings	25 kV class ratings	35 kV class ratings
Operating voltage maximum line-to-ground (kV) (see application info note 1)	8.3	15.2	21.1
BIL impulse withstand 1.2 x 50 microsecond wave (kV)	95	125	150
Withstand voltage AC one minute DC 15 minute (kV)	34 53	40 78	50 103
Corona extinction level @ 3pc sensitivity (kV)	11	19	26
200 A products Continuous current: Symmetrical momentary current:	–	–	200 A 10 kA sym, 10 cycle duration*
600 Series products Continuous current: Symmetrical momentary current:	–	–	600 and 900 A 25 kA sym, 10 cycle duration*

\* Designed for 90 °C maximum continuous operating temperature.

**Application information:**

1. Loadbreak connectors are designed and rated for use on grounded Wye systems. For application on ungrounded Wye or delta systems, the next higher voltage class product is recommended.

**Examples:**

- 5 kV ungrounded: use 15 kV class products;
- 15 kV ungrounded: use 25 kV class products;
- 25 kV ungrounded: use 35 kV class products.

2. Products are designed and constructed for all applications, including padmount, subsurface, vault, indoor, outdoor, direct sunlight, direct buried and continuously submerged in water.

3. Products are designed and rated for ambient temperatures of -40 °C to 65 °C. It is recommended that loadbreak connectors be hotstick operated at -20 °C to 65 °C ambient temperature range and at altitudes not exceeding 6000 feet.

**Switching and fault close ratings**

	<b>Loadmake/loadbreak switching</b>	<b>Fault close</b>
15 kV class ratings	1 $\emptyset$ and 3 $\emptyset$ circuits 8.3 kV line to ground, 14.4 kV max. across open contacts 10 loadmake/break operations at 200 A max. with 70 to 80% lagging power factor	1 fault close operation at 8.3 kV or 14.4 kV; 10,000 A RMS sym; 10 cycles (0.17 sec.) 1.3 max. asym factor applies to new or used mating parts (up to maximum designated switching operations)
25 kV class ratings	1 $\emptyset$ and 3 $\emptyset$ circuits 15.2 kV line to ground, 26.3 kV max. across open contacts 10 loadmake/break operations at 200 A max. with 70 to 80% lagging power factor	1 fault close operation at 15.2 kV or 26.3 kV; 10,000 A RMS sym; 10 cycles (0.17 sec.) 1.3 max. asym factor applies to new or used mating parts (up to maximum designated switching operations.)
35 kV class ratings	1 $\emptyset$ and 3 $\emptyset$ circuits 21.1 kV line to ground, 36.6 kV max. across open contacts. 10 loadmake/break operations at 200 A max. with 70 to 80% lagging power factor.	1 fault close operation at 21.1 kV or 36.6 kV; 10,000 A RMS sym; 10 cycles (0.17 sec.) 1.3 max. asym factor applies to new or used mating parts (up to maximum designated switching operations)

\* Designed for 90 °C maximum continuous operating temperature.

## Elastimold underground cable accessories





### Overview

#### Standard interfaces for separable connectors, components and equipment bushing

The latest revision of IEEE standard 386 defines the specific interface dimensions to which 200 A and 600 series elbows, inserts, junctions, equipment bushings and any mating components must

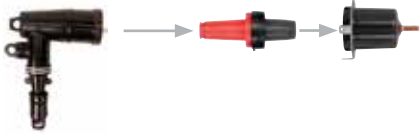
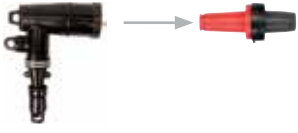
conform to ensure interchangeability. The table below provides information concerning the types of interfaces supplied by Elastimold products for various applications and is useful to ensure proper matching of components.

#### Types of interfaces supplied by Elastimold

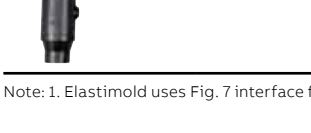
	Bushing interface	Voltage class (kV)	Interface description	Standard no. Figure no.
	200 A deepwell equipment bushing	15, 25 and 35	200 A bushing well interface 8.3 kV, 15.2 kV and 21.1 kV	IEEE 386 Fig. 3
	200 A loadbreak insert	15	200 A loadbreak 8.3 kV and 8.3 kV/14.4 kV	IEEE 386 Fig. 5
	200 A loadbreak insert	25	200 A loadbreak 15.2 kV and 15.2 kV/26.3 kV	IEEE 386 Fig. 7, Note 1
	200 A loadbreak insert	35	200 A loadbreak interface no. 2 21.1 kV and 21.1 kV/36.3 kV	IEEE 386 Fig. 7, Note 1
	200 A deadbreak insert	15 and 25	200 A deadbreak 8.3 kV and 15.2 kV	IEEE 386 Fig. 4
	600 Series equipment bushing	15 and 25	600 A deadbreak interface no. 1 8.3 kV and 15.2 kV	IEEE 386 Fig.11
	600 Series equipment bushing	35	600 A deadbreak interface no. 1 21.1 kV	IEEE 386 Fig.13

Note: 1. Elastimold uses Fig. 7 interface for both 25 and 35 kV applications.

---

## 200 A loadbreak elbows

### Connectors and accessories

200 A loadbreak connectors and accessories provide a convenient method to connect/disconnect cable and equipment on power distribution systems. Loadbreak elbows include provisions for energized operation using standard hotstick tools, allowing loadmake/break operation and a visible disconnect. Components can be isolated with insulated caps, plugs and parking bushings.

Optional accessories allow system grounding, testing, bypass, surge protection and current limiting fusing. Additional connecting points and taps can be provided by use of junctions or feed-thrus.

---

### Elastimold 200 A loadbreak elbow (15 kV and 25 kV)

#### **Switching made easier**

The Elastimold 200 A loadbreak elbow (15 kV and 25 kV series) incorporates decades of innovative design and manufacturing experience that directly addresses end users' needs. The design incorporates safety performance features, increases range flexibility and improves life cycle cost reduction. In addition, Elastimold 200-amp loadbreak elbow has Rural Utilities Service (RUS) acceptance from the U.S. Department of Agriculture (USDA), which authorizes its use in rural infrastructure construction and improvements.

#### **Enhance safety**

- Rigid probe support to ensure proper switching
- No stick interface when used with Elastimold bushings (NEETRAC\* tested)
- Robust stainless-steel pulling eye
- Dual grounding eye positions

#### **Increase flexibility**

- Additional sizes available
- Improved wider cable ranges
- Easy order system
- Optional integral jacket seal

#### **Improve life cycle cost reduction**

- Optimized for switching operations
- Lifetime ease of operation and non-stick when used with Elastimold bushings
- Seal system for traditional and jacket seal options

IEEE 386 compliant

ANSI certification

Rural Utilities Service (RUS) acceptance

\* National Electric Energy Testing, Research and Applications Center

## 200 A loadbreak elbows

### Overview

—  
01 15/25 kV class  
—  
02 15/25 kV class

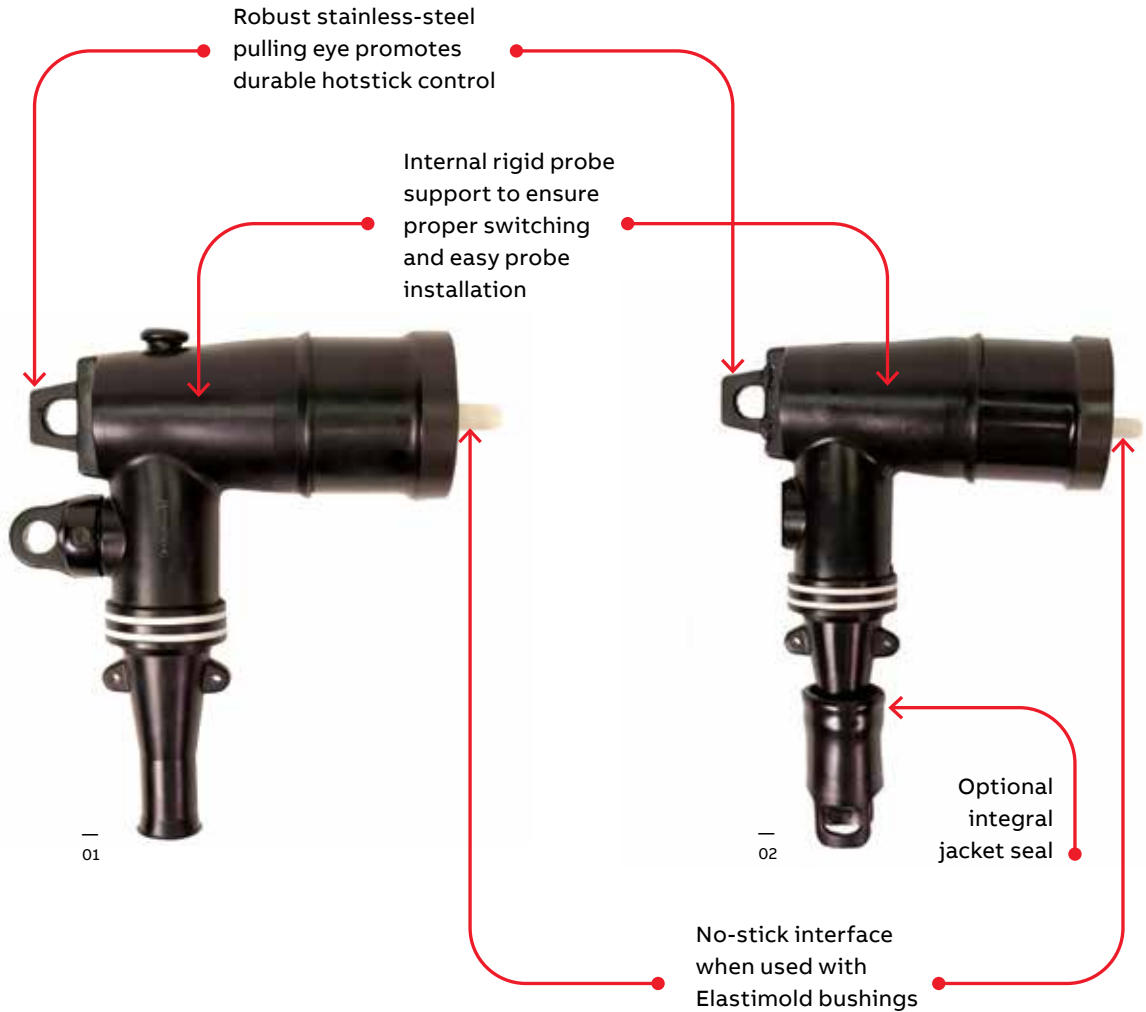

### Ratings overview

See pages A4–A5 for complete information, including switching and fault close ratings.

#### Current ratings

- 200 A continuous
- 10 kA sym. 10 cycles

#### Voltage ratings

- 15 kV class
- 8.3 kV phase-to-ground
- 14.4 kV phase-to-phase
- 95 kV BIL
- 34 kV AC withstand
- 53 kV DC withstand
- 11 kV corona extinction

#### 25 kV class

- 15.2 kV phase-to-ground
- 26.3 kV phase-to-phase
- 125 kV BIL
- 40 kV AC withstand
- 78 kV DC withstand
- 19 kV corona extinction

#### 35 kV class

- 21.1 kV phase-to-ground
- 36.6 kV phase-to-phase
- 150 kV BIL
- 50 kV AC withstand
- 103 kV DC withstand
- 26 kV corona extinction



## 200 A loadbreak separable connectors

### Components

#### Cable to equipment connections

ABB offers the complete package of underground cable accessories – everything you need to connect, ground, splice, terminate and protect underground

cable from 5 kV to 138 kV – along with solid dielectric switchgear in compact, modular designs that fit easily into tight vaults.

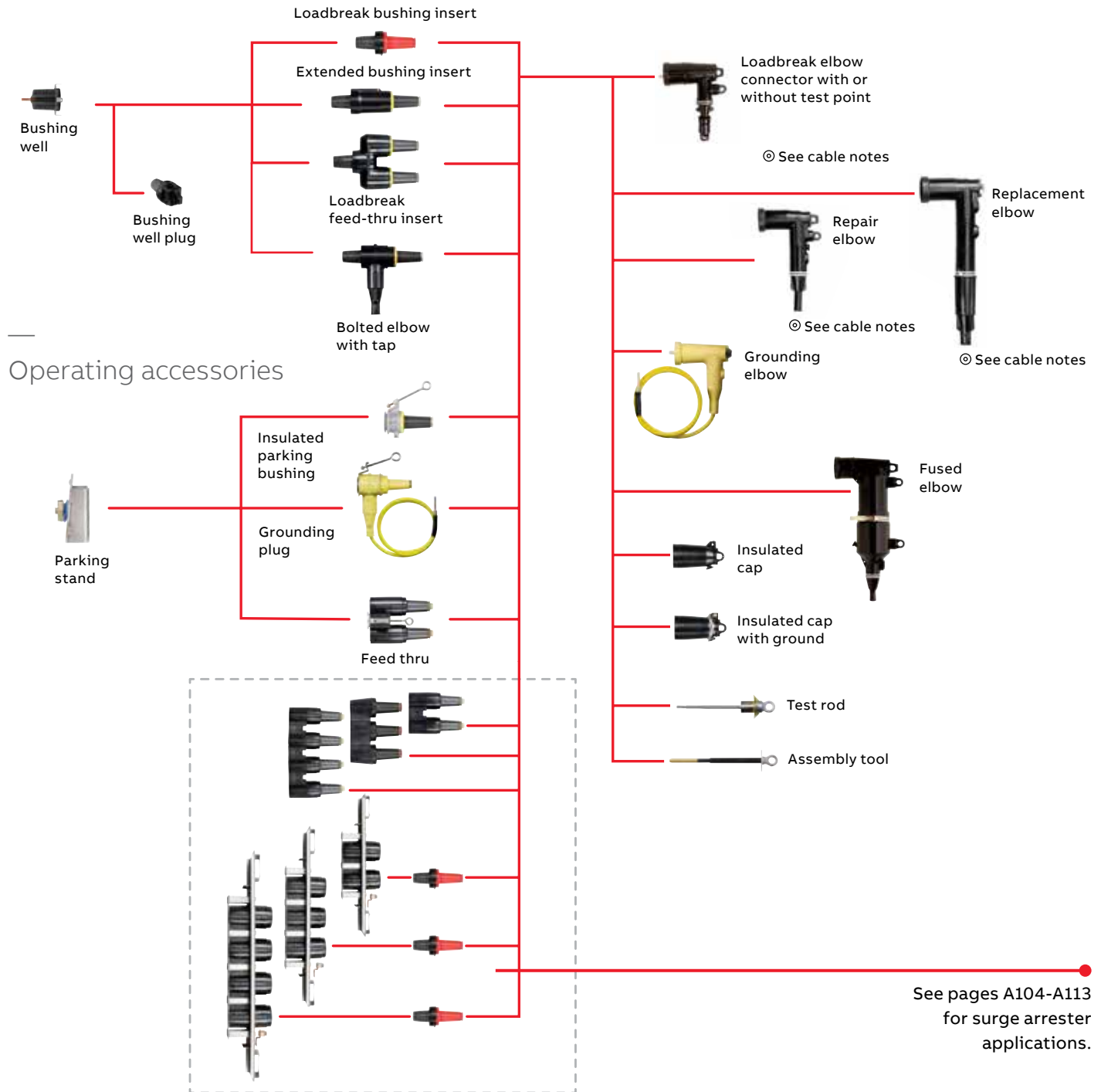

## 200 A loadbreak separable connectors

### Loadbreak elbows

Image (not to scale)	Description	Voltage class (kV)	Cat. no.	Notes
	Elbow connector without test point	15	161LR-W5X Use tables W1 and X1	N2, 3, 4, 5
		25	261LR-W5X Use tables W1 and X1	N2, 3, 4, 5
		35	375LR-W5X Use tables W3 and X2	N2, 3, 5
	Elbow connector with test point	15	162LR-W5X Use tables W1 and X1	N2, 3, 4, 5, 23
		25	262LR-W5X Use tables W1 and X1	N2, 3, 4, 5, 23
		35	376LR-W5X Use tables W3 and X2	N2, 3, 5, 23
	Jacket seal elbow connector without test point	15	161LRJS-W5X Use tables W1 and X1	N2, 19
		25	261LRJS-W5X Use tables W1 and X1	N2, 19
	Jacket seal elbow connector with test point	15	162LRJS-W5X Use tables W1 and X1	N2, 19, 23
		25	262LRJS-W5X Use tables W1 and X1	N2, 19, 23
	Repair elbow connector	15	167ELR-W5X Use tables W5 and X1	N5, 10, 18
		25	273ELR-W5X Use tables W5 and X1	N5, 10, 18
	Repair elbow connector with test point	15	168ELR-W5X Use tables W5 and X1	N5, 10, 18, 23
		25	274ELR-W5X Use tables W5 and X1	N5, 10, 18, 23
	Replacement elbow	15	167RLR-W5X Use tables W4 and X1	N5, 11, 13
		25	273RLR-W5X Use tables W2 and X1	N5, 11, 13
	Replacement elbow with test point	15	168RLR-W5X Use tables W4 and X1	N5, 11, 13, 23
		25	274RLR-W5X Use tables W2 and X1	N5, 11, 13, 23
	Direct test elbow connector	15	161DLR-W5X Use tables W1 and X1	N2, 5, 21
		25	261DLR-W5X Use tables W1 and X1	N2, 5, 21
	Direct test repair elbow connector	15	167DELR-W5X Use tables W5 and X1	N5, 10, 18, 21
		25	273DELR-W5X Use tables W5 and X1	N5, 10, 18, 21
	Direct test repair elbow connector with test point	15	168DELR-W5X Use tables W5 and X1	N5, 10, 18, 21, 23 3
		25	274DELR-W5X Use tables W5 and X1	N5, 10, 18, 21, 2

**N1.** Copper lug for use on COPPER CONDUCTOR ONLY.

**N2.** W5X indicates that the catalog number includes 02500X long bi-metal compression lug as standard. For an all-copper lug, replace W5X with W2X in Table X1 to specify the all-copper 02702X lug.

**N3.** Also available as housing only. Specify: 161BLR-W; 261BLR-W; 375BLR-W; 162BLR-W; 262BLR-W; 376BLR-W.

**N4.** Also available as elbow with insert combination. Specify: 161A4-WX; 261A4-WX; 162A4-WX; 262A4-WX.

**N5.** Also available with 200ECS jacket seal included. Add - "S" suffix to catalog number (highly recommended).

**N10.** Repair elbow has extended length contact and elbow housing resulting in a net gain of 3/4" in length.

**N11.** Replacement elbow has extended-length contact and elbow housing resulting in a net gain of 8/16" in length.

**N13.** Includes long bi-metal contact 00400X.

**N18.** Includes 02509X long bi-metal contact.

**N19.** Includes built-in jacket seal. Also available as housing only – specify: 161BLRJS-W, 162BLRJS-W, 261BLRJS-W or 262LRJS-W. Also available as elbow with insert combination – specify: 161JSA4-W5X, 162JSA4-W5X, 261JSA4-W5X or 262JSA4-W5X.

**N21.** Direct test connectors, along with a 200TC-X series meter adapter, a properly rated voltage meter and hot-line stick provide a means for direct conductor voltage testing.

**N23.** Test point cap catalog number 156-7

Refer to the W and X tables on pages A54–A55 for sizing to cable insulation diameter and conductor size. For cable shield adapters and jacket seals, see pages A44–A45.

## 200 A loadbreak separable connectors

### Loadbreak bushings





















Image (not to scale)	Description	Voltage class (kV)	Cat. no.	Notes
	Grounding plug (1/0 AWG x 6' ground lead)	15	161GP	-
		25	272GP	-
	Grounding elbow (1/0 AWG x 6' ground lead)	15	160GLR	N12
		25/35	370GLR	N12
	Feed-thru	15	164FT	N6, N18
		25	274FT	N6, N18
		35	371FT	N6, N18
		35	373FT	N6, N18
	Feed-thru vertical	15	164FTV	-
		25	274FTV	-
		35	373FTV	-
	Adjustable bracket 2-point feed-thru	15	164FT2-AB	N22
		25	274FT2-AB	N22
		35	373FT2-AB	N22
	Adjustable bracket 3-point feed-thru	15	164FT3-AB	N22
		25	274FT3-AB	N22
		35	373FT3-AB	N22
	Adjustable bracket 4-point feed-thru	15	164FT4-AB	N22
		25	274FT4-AB	N22
		35	373FT4-AB	N22
	Feed-thru well	15/25	K1601WFT	-
	Feed-thru well vertical	15/25	K1601WFTV	-
	Insulated parking bushing	15	161SOP	N20
		25	272SOP	N20
		35	372SOP	N20
	Insulated parking bushing	15	164SOP	N22
		25	274SOP	N22
	Assembly tool	All	200AT	N8
	Bushing well plug	15/25	276BWP	-
		35	M276BWP	-
	Test rod	All	370TR	-
	Bolted elbow with tap	15	167LRT-W5X Use tables W4 and X1	N17
	Bushing insert	15	1601A4	N4, 8
		25	2701A4	N4, 8
		35	3701A4	N6, 20
		35	3701A3	20

Image (not to scale)	Description	Voltage class (kV)	Cat. no.	Notes
	Extended bushing insert	15	1601EA4	N8
		25	2701EA4	N8
	Feed-thru insert	15	1602A3R	N16
		25	2702A1	N16
		35	3702A1	N6, 16
	Insulated cap	15	160DR	N9
	Insulated cap with ground	15	160DRG	N9
		15	167DRG	N7, 9
		25	273DRG	N7, 9
		35	375DRG	N7, 9
	Insulated cap with ground and test point	15	168DRG	N7
		25	274DRG	N7
		35	376DRG	N7

**N4.** Also available as elbow with insert combination. Specify: 161A4-WX; 261A4-WX; 162A4-WX; 262A4-WX.

**N6.** Rated for single-phase applications only.

**N7.** Equipped with insulated cuff.

**N8.** Includes internal torquing feature using 200AT assembly tool.

**N9.** Also available without probe. Specify "A" suffix - Example: 273DRGA.

**N12.** Rated for 25 kV thru 35 kV applications.

**N16.** Fully rotatable for 360° positioning. Includes bail assembly to secure feed-thru insert to bushing well.

**N17.** Includes 02800X bi-metal contact.

**N18.** Includes 02509X long bi-metal contact.

**N20.** Includes a black vent ring.











**N22.** With stainless steel bracket.

Refer to the W and X tables on pages A54–A55 for sizing to cable insulation diameter and conductor size. For cable shield adapters and jacket seals, see pages A44–A45.

## 200 A loadbreak separable connectors

### Connectors and accessories

#### Connectors and accessories

Image (not to scale)	Description	Voltage class (kV)	Cat. no.	Notes		
	Contacts: LR long bi-metal	All	Use Table X1 02500X	–		
	ELR bi-metal	15/25	02509X	N1		
	LR copper	All	02702X	N2		
	LRT contact	15	02800X	–		
	RLR contact	15/25	00400X	N3		
	Elbow probe	15	166LRF	–		
		35	375LRF	–		
	Elbow cable entrance insulating plug	All	10EP-W	–		
			Use Table W6			
	Cable size adapter	15	160CA-W	N4		
			Use Table W6 EB-FA Only			
	Direct voltage test meter adapter for: HD electric meters	All	200TC-1	N14		
			Ross meters	–	200TC-2	N14
			Chance meters	–	200TC-4	N14
	2-Way well junction with stainless steel bracket	15/25	K1601WJ2	N6		
			15/25	K1601WJ2-5	N5, 6, 11	
	3-Way well junction with stainless steel bracket	15/25	K1601WJ3	N6		
			15/25	K1601WJ3-5	N5, 6, 12	
	4-Way well junction with stainless steel bracket	15/25	K1601WJ4	N6		
			15/25	K1601WJ4-5	N5, 6, 13	
	2-Point junction with stainless steel bracket	15	164J2	N7		
		25	274J2	N7		
		35	373J2	N7		
	2-Point junction with "U" straps	15	164J2-5	–		
		25	274J2-5	N5, 8 N5, 11		
		35	373J2-5	N5, 11		
	3-Point junction with stainless steel bracket	15	164J3	N7		
		25	274J3	N7		
		35	373J3	N7		
	3-Point junction with "U" straps	15	164J3-5	N5, 9		
		25	274J3-5	N5, 12		
		35	373J3-5	N5, 12		
	4-Point junction with stainless steel bracket	15	164J4	N7		
		25	274J4	N7		
		35	373J4	N7		
	4-Point junction with "U" straps	15	164J4-5	N5, 10		
		25	274J4-5	N5, 13		
		35	373J4-5	N5, 13		

**N1.** Repair elbow has extended-length contact and elbow housing resulting in a net gain of 3¼" in length.

**N2.** Copper lug for use on COPPER CONDUCTOR ONLY.

**N3.** Replacement elbow has extended-length contact and elbow housing resulting in a net gain of 8¾" in length.

**N4.** 160CA cable size adapter can only be used with elbow catalog numbers 165LR/166LR C, H or CC size only.

**N5.** Also available as rubber only, without straps.

Specify suffix "-4" in place of "-5" in the catalog number.

**N6.** Supplied with replaceable stud. Replacement stud available separately. Specify 1000-150.

**N7.** Hardware packages, consisting of brackets and straps only, may be ordered separately by specifying "-6" in the catalog number. Example 164J4-6.

**N8.** Hardware package, consists of "U" straps and back plate only, may be ordered separately by specifying 1601US-J2.

**N9.** Hardware package, consists of "U" straps and back plate only, may be ordered separately by specifying 1601US-J3.

**N10.** Hardware package, consists of "U" straps and back plate only, may be ordered separately by specifying 1601US-J4.

**N11.** Hardware package, consists of "U" straps and back plate only, may be ordered separately by specifying 271-68.

**N12.** Hardware package, consists of "U" straps and back plate only, may be ordered separately by specifying 271-61.

**N13.** Hardware package, consists of "U" straps and back plate only, may be ordered separately by specifying 271-70.

**N14.** For use with direct test connectors.

Refer to the W and X tables on pages A54–A55 for sizing to cable insulation diameter and conductor size. For cable shield adapters and jacket seals, see pages A44–A45.

---

## 200 A deadbreak separable connectors

### Connectors and accessories

200 A deadbreak connectors and accessories provide a quick-disconnect feature for cable and equipment connections on power distribution systems.

All deadbreak connectors must be de-energized before operating and must be mechanically secured with bails when connected. Components can be isolated with insulated caps, plugs and parking bushings.

All deadbreak elbows are equipped with test points as standard. Optional accessories allow system grounding, bypass and lightning surge protection. Additional connecting points and taps can be provided by use of junctions or feed-thrus.

#### **Ratings overview**

See pages A4–A5 for complete information.

#### **Current ratings**

- 200 A continuous
- 10 kA sym. 10 cycles

#### **Voltage ratings**

##### **15 kV class**

- 8.3 kV phase-to-ground
- 14.4 kV phase-to-phase
- 95 kV BIL
- 34 kV AC withstand
- 53 kV DC withstand
- 11 kV corona extinction

##### **25 kV class**

- 15.2 kV phase-to-ground
- 26.3 kV phase-to-phase
- 125 kV BIL
- 40 kV AC withstand
- 78 kV DC withstand
- 19 kV corona extinction

## 200 A deadbreak separable connector components

Cable to equipment

Operating accessories



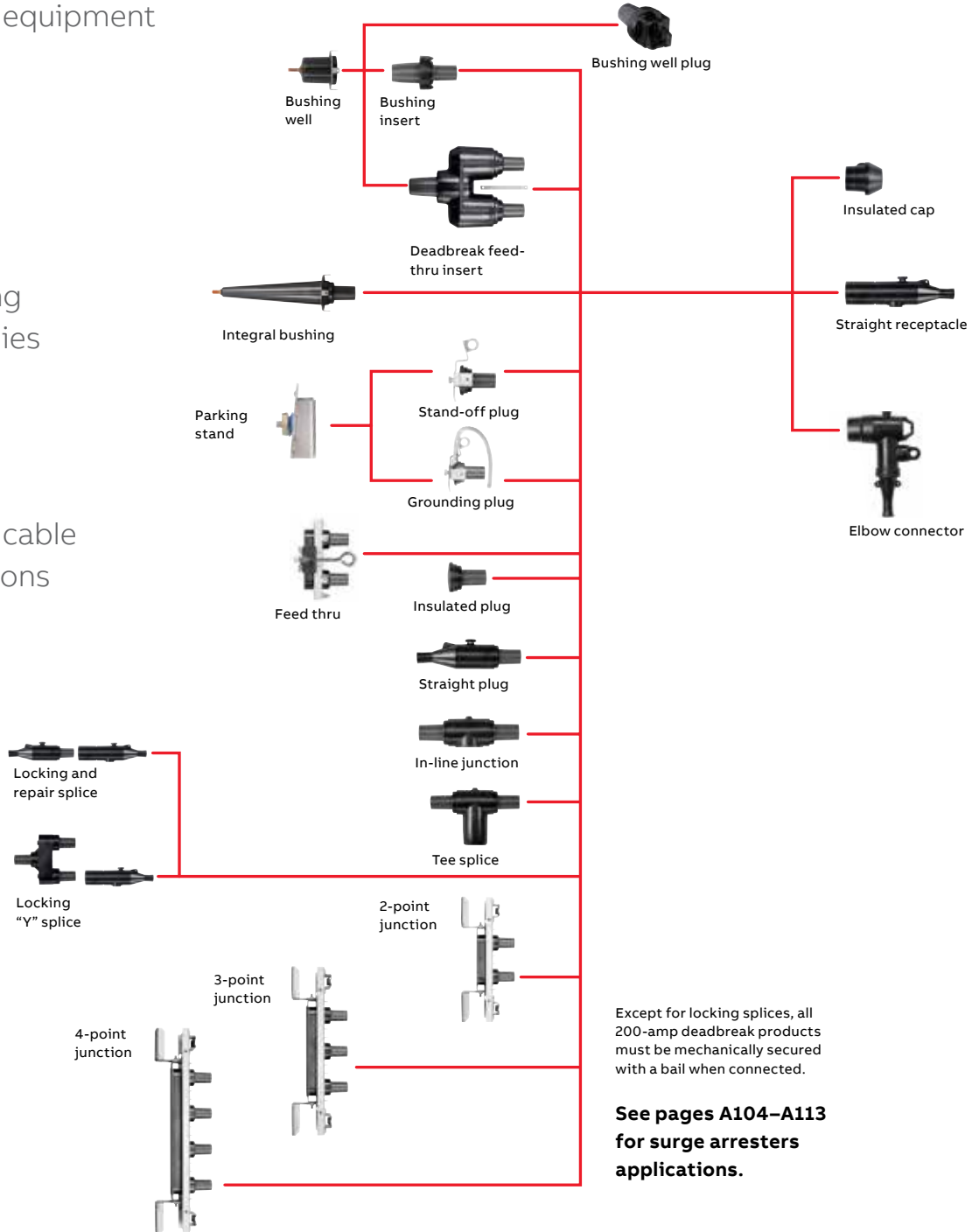













Cable to cable connections



## 200 A deadbreak separable connectors

### Connectors and accessories

#### 200 A deadbreak separable connectors

Image (not to scale)	Description	Voltage class (kV)	Cat. no.	Notes
	Elbow connector with test point	15/25	252LR-W0X Use tables W16 and X1	N1, 2
	Jacket seal elbow connector with test point	15/25	252LRJS-W5X Use tables W16 and X1	N2, 19
	Bail assembly for 156LR elbow	15/25	150BA	–
	Bushing insert	15/25	K1501A1	N3
	Feed-thru insert	15/25	K1502A1	N3, 4
	Insulated plug	15/25	K150DP	N3
	Insulated cap	15/25	K150DR	N3
	Insulated parking bushing	15/25	K151SOP	N3
	Grounding plug	15/25	151GP	N3
	Feed-thru	15/25	K1501FT	N3, 6
	2-point junction	15/25	K1501J2-U8	N3, 6
	3-point junction	15/25	K1501J3-U8	N3, 6
	4-point junction	15/25	K1501J4-U8	N3, 6
	Elbow probe	15/25	156LRF DP 0438609	–
	Straight receptacle	15/25	K151SR-W0X Use tables W1 and X1	N3, 12, 13, 17, 18
	Straight plug	15/25	K151SP-W0X Use tables W1 and X1	N3, 12, 13, 19

**N1.** Includes bail assembly.

**N2.** W5X indicates that the catalog number includes a 02500X bi-metal compression lug, which is rated for either aluminum or copper conductor, as standard. For an all-copper lug, replace W5X with W2X. Use Table X1 to specify the all-copper 02702X lug.

**N3.** Bails are required but not included. Order separately. Consult factory for bails not listed for a specific application.

**N4.** Fully rotatable for 360° positioning. Includes bail assembly to secure feed-thru insert to bushing well. Elbows bail assemblies are required but not included with the feed-thru insert.

**N6.** Center-to-center spacing equals 4 inches.

**N12.** Also available as housing only. Specify K151BSP-W or K151BSR-W.

**N13.** Also available in EB-FA sizes per Table W6 by using 160CA cable adapter with C size plugs and receptacles.

**N17.** Straight receptacles are also available with test point. Specify K152SR-W0X catalog number.

**N18.** W0X indicates that the catalog number includes a 01500X universal aluminum compression lug, which is rated for either aluminum or copper, as standard. For an all-copper lug, replace W0X with W2X in Table X1 to specify the all-copper 01502X lug.

**N19.** W0X indicates that the catalog number includes a 01600X universal aluminum compression lug, which is rated for either aluminum or copper, as standard. For an all-copper lug, replace W0X with W2X in Table X1 to specify the all-copper 01602X lug.















**N22.** Direct test connectors, along with a 200TC-X series meter adapter, a properly rated voltage meter and hot-line stick provides a means for direct conductor voltage testing. See page A12 for meter adapters.

Refer to the W and X tables on pages A54–A55 for sizing to cable insulation diameter and conductor size. For cable shield adapters and jacket seals, see pages A44–A45.

## 200 A deadbreak separable connectors

### Connectors and accessories

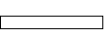
#### 200 A deadbreak connectors and accessories

Image (not to scale)	Description	Voltage class (kV)	Cat. No.	Notes
	Tee splice	15/25	K150T	N3
	In-line junction	15/25	K150S	N3
	Locking splice/ repair splice	15/25	K151LS-W0X Use tables W1 and X1	N8, 9, 13, 15, 16, 17, 20, 23
	Locking "Y" splice	15/25	K151LY-W0X Use tables W1 and X1	N8, 9, 13, 15, 17, 21
	Bail	15/25	150TB1	N5
	Bail	15/25	150TB2	N5
	Bail	15/25	150TB3	N5
	Bail	15/25	150TB4	N5
	Bail	15/25	150TB5	N5
	Bail	15/25	150TB6	N5
	Contacts: long bi-metal copper	15/25 15/25	02500X 02702X	N7
	Elbow cable entrance insulating plug	15/25	10EP-W Use table W6	N10
	Cable entrance insulating plug	15/25	152EA-W Use table W6	N11
	Cable size adapter	15/25	160CA-W Use table W6 EB-FA only	N14

**N3.** Bails are required but not included. Order separately. Consult factory for bails not listed for a specific application.

**N5.** Refer to factory for application details.

**N7.** Copper lug for copper cable only.

**N8.** To order cable legs for different cable sizes, list each leg size "W" and "X". Example: K151LY-A1240-A1240-B1220. See Tables W1 and X1 for sizes.

**N9.** To order locking contacts for K151LS and K151LY, order 01401X (Al) or 01402X (Cu) for plug contact. Order 01301X (Al) or 01302X (Cu) for receptacle. See Table X1 for sizes.

**N10.** For use with 156LR elbows.

**N11.** For use with K151SR, K151SP, K151LS, K151LY receptacles, plugs and splices.

**N13.** Also available in EB-FA sizes per Table W6 by using 160CA cable adapter with C size plugs and receptacles.

**N14.** 160CA cable adapter can only be used with C size plugs and receptacles.

**N15.** Bails are not required for locking splices.

**N16.** When used as a repair splice, the assembled length allows 4" for cable replacement/repair.

**N17.** Straight receptacles are also available with test point. Specify K152SR-W0X catalog number.

**N20.** W0X indicates that the catalog number includes a 01400X universal aluminum compression lug, which is rated for either aluminum or copper, as standard. For an all-copper lug, replace W0X with W2X in Table X1 to specify the all-copper 01402X lug.

**N21.** W0X indicates that the catalog number includes a 01300X universal aluminum compression lug, which is rated for either aluminum or copper, as standard. For an all-copper lug, replace W0X with W2X in Table X1 to specify the all-copper 01302X lug.

**N23.** Gains approximately 4" of repair length.

Refer to the W and X tables on pages A54–A55 for sizing to cable insulation diameter and conductor size. For cable shield adapters and jacket seals, see pages A44–A45.



## 600 A deadbreak separable connectors

### 600 series deadbreak components

600 Series deadbreak elbows, straight receptacles, junctions, vault stretchers and accessories are used to connect equipment and cable on primary feeder and network circuits. Designs accommodate large conductors and feature bolted connections and deadfront modular construction for maximum reliability, performance and versatility. De-energized connectors can be quickly and easily connected and disconnected using standard hand tools and equipment in accordance with accepted operating practices. Optional accessories allow visible external separation, bypass, isolation, dead-ending, grounding and testing as well as adding taps, surge arresters and circuit protection. Hotstick-operable and separable joint systems are shown on pages A22–A28.

### Spiking aid

When spiking a medium voltage cable near a separable connector, the Elastimold spiking aid is a specially designed product to reduce outage time and cost. Medium voltage cable is spiked as a means to ensure the circuit is de-energized where there is no sectionalizing device, direct testing means or provision for grounding.

### GAD

When available fault currents exceed 10 kA in underground systems, the Elastimold GAD may provide a solution. The Elastimold GAD is rated 25 kA and installs in the rear interface of a 600 series elbow connector (T-body). The GAD is normally covered and insulated with an insulating cap that contains capacitive test and a hotstick operating band. Once the circuit is opened at a disconnecting device, the test point cap is removed with a hotstick, and then using an appropriate capacitive test point meter, the test point is checked for voltage. The insulating cap is then removed with a hotstick and a high voltage meter is used to confirm the de-energized state before a ground cable is connected.

### Ratings overview

See pages A4–A5 for complete information.

#### Current ratings

**(Prefixes: 650, K650, K651, K655, K656, 750, 755, 756 and 03700)**

- 600 A continuous
- 25 kA sym., 10 cycles

**(Prefixes 675, K671, K675, K676, 775, 776 and 03702)**

- 900 A continuous
- 25 kA sym., 10 cycles

Note: 900 A ratings require copper cable and copper current-carrying components.

#### Voltage ratings

**15/25 kV class (5 kV thru 28 kV)**

- 16.2 kV phase-to-ground
- 28 kV phase-to-phase
- 140 kV BIL
- 45 kV AC withstand
- 84 kV DC withstand
- 21.5 kV corona extinction

**35 kV class**

- 21.1 kV phase-to-ground
- 36.6 kV phase-to-phase
- 150 kV BIL
- 50 kV AC withstand
- 103 kV DC withstand
- 26 kV corona extinction

Note: Elastimold has increased the IEEE Standard Production and Design Test levels for 25 kV class products to include 27 kV and 28 kV systems.

\* Tested at 8.3/14.9 kV

† Tested at 15.2/26.3 kV

• Tested at 21.1/36.6 kV

# 600 A deadbreak separable connectors

## 600 series deadbreak components

- \* Tested at 8.3/14.9 kV
- † Tested at 15.2/26.3 kV
- Tested at 21.1/36.6 kV

### Cable to equipment

See pages A104–A113 for surge arrester applications.



Integral bushing

### Cable to cable (using junctions)

See pages A34–A37 for additional junctions

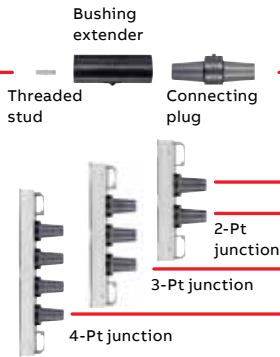

### Operating accessories



### Straight receptacle

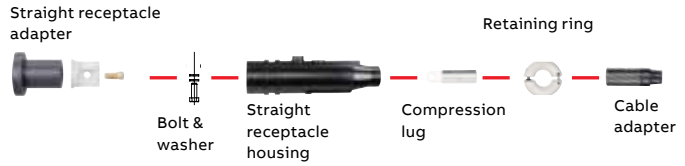

### Elbow connector

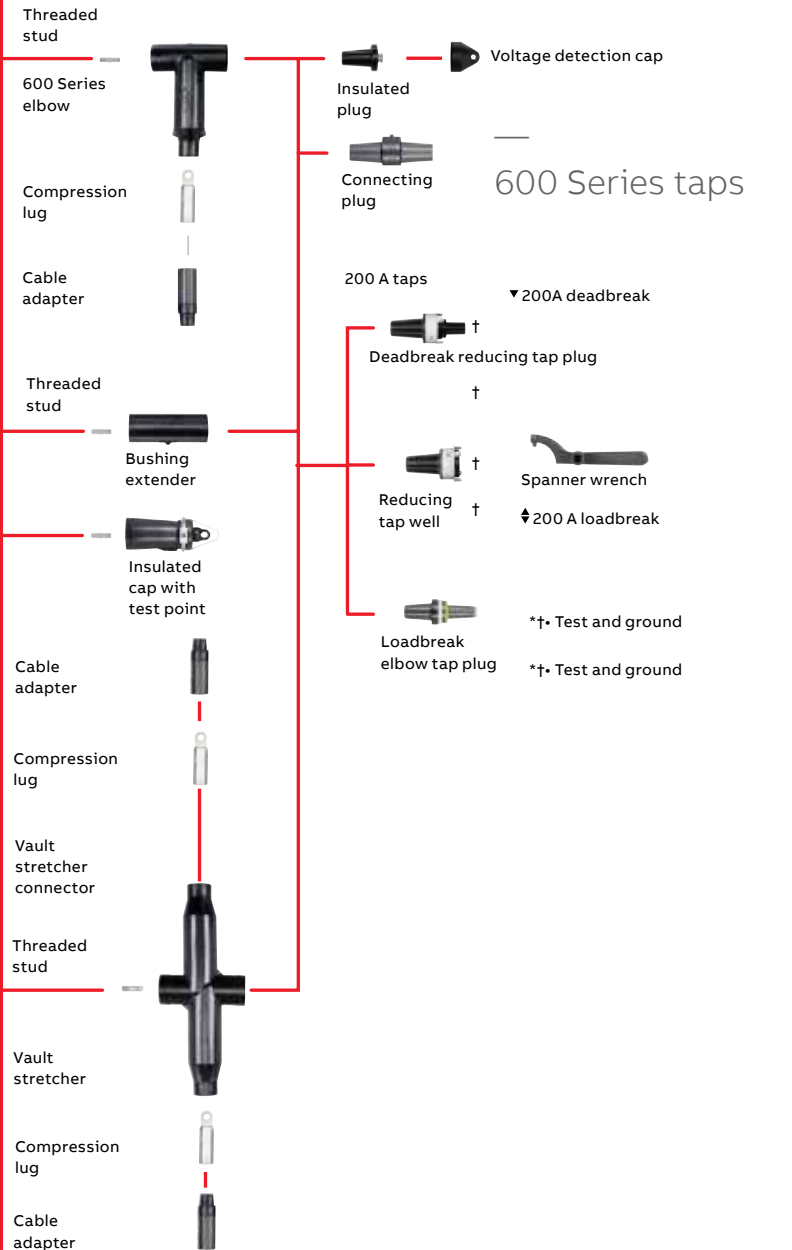

### 600 Series taps

▼ 200A deadbreak











Spanner wrench  
◆ 200 A loadbreak

\*†• Test and ground  
\*†• Test and ground

## 600 A deadbreak separable connectors

### 600 A deadbreak elbows

#### 600 A deadbreak elbows

Image (not to scale)	Description	Voltage class (kV)	Cat. no.	Notes
	600 Series elbow (with insulating plug, cap, stud, lug and cable adapter)	15/25	K655LR-WOX Use tables W7 and X6	N1, 2
		35	755LR-WOX Use tables W9 and X6	N1, 2, 15
	600 Series direct test elbow (with insulating plug, cap, stud lug and cable adapter)	15/25	K655DLR-WOX Use tables W7 and X6	N1, 2, 12
		35	755DLR-WOX Use tables W9 and X6	N1, 2, 12, 15
	600 Series elbow with test point (with insulating plug, cap, stud, lug and cable adapter)	15/25	K656LR-WOX Use tables W7 and X6	N1, 2
		35	756LR-WOX Use tables W9 and X6	N1, 2, 15
	600 Series direct test elbow with test point (with insulating plug, cap, stud, lug and cable adapter)	15/25	K656DLR-WOX Use tables W7 and X6	N1, 2, 12
		35	756DLR-WOX Use tables W9 and X6	N1, 2, 12, 15
	600 Series elbow without test point housing only (with stud)	15/25	K655BLR	N1, 3
		35	755BLR	N1, 3, 15
	600 Series elbow with test point housing only (with stud)	15/25	K656BLR	N1, 3
		35	756BLR	N1, 3, 15
	600 Series straight receptacle (with cable adapter, lug and retaining ring)	15/25	K655SR-WOX Use tables W7 and X6	N1, 2, 11
	600 Series direct test straight receptacle elbow	15/25	K655DSR-WOX Use tables W7 and X6	N1, 2, 11, 12
	600 Series straight receptacle housing (lug and cable adapter not included)	15/25	K655BSR	N1,11
	Straight receptacle adapter	15/25	K650SRA	N1, 4
	600 Series vault stretcher (housing only with stud)	15/25 kV	K655BVS	N1, 9
		35 kV	755BVS	N1, 9

**N1.** For 900 A ratings, substitute 675 for 650 and 655; 676 for 656; K671 for K651; K675 for K650 and K655; K676 for K656; 775 for 750 and 755; 776 for 756 and 2X for 0X in the catalog number. The 900 A rating requires copper current-carrying connector components and copper conductor cable.

**N2.** Add suffix symbol from page A17 to include cable shield grounding kit and/or cable jacket sealing kit.

**N3.** Available without the stud by adding "N" to the catalog number.

**N4.** Straight receptacle adapter is used to connect straight receptacles K655YBSR and K655YSR-WOX (page A33) to equipment bushings.

**N5.** Aluminum lug for use on aluminum or copper conductors. DO NOT substitute threaded 03600X lug.

**N6.** Copper lug for use on COPPER CONDUCTOR ONLY.

DO NOT substitute threaded 03602X lug.

**N7.** Available with the stud factory-assembled by adding "SP" to the catalog number. 675ETP, K675ETP and 775ETP are available as -SP only. The stud is not field removable.

**N8.** Available with a loose stud by adding suffix "S" to the catalog number.

**N9.** 600SW spanner wrench is recommended for installation of deadbreak reducing tap plugs and reducing tap wells.

**N10.** Use 600ATM assembly tool.

**N11.** 600 Series elbows and straight receptacles with IEEE Std. 386 capacitive test points are available by substituting 656 for 655; K656 for K655; K676 for K675; 756 for 755; 676 for 675; K676 for K675 and 776 for 775 in the catalog number.

**N12.** Direct test connectors, along with a 200TC-X series meter adapter, a properly rated voltage meter and hot-line stick; provides a means for direct conductor voltage testing.

**N13.** With stainless steel bracket.

**N15.** Available with 200 kV BIL adding suffix "-200".





















**N16.** Bimetallic Lug for use on aluminum or copper conductors. DO NOT substitute threaded 05501X lug

Refer to the W and X tables on pages A54–A55 for sizing to cable insulation diameter and conductor size. For cable shield adapters and jacket seals, see pages A44–A45.

## 600 A deadbreak separable connectors

### 600 series deadbreak components

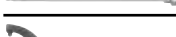
#### 600 A deadbreak accessories

Image (not to scale)	Description	Voltage class (kV)	Cat. no.	Notes
	Cable size adapter	15/25	655CA-W Use tables W7	-
		35	755CA-W Use tables W9	-
	Compression lug	All	03700X Use tables X6	N5
		All	03702X Use tables X6	N6
	Bimetallic compression lug	All	04601XXX Use Table X6	N16
	Epoxy connecting plug	15/25	K650CP	N9
	600 Series elbow and vault stretcher size sensitive kit (cable adapter and lug)	15/25	655CK-W0X Use tables W7 and X6	N2
		35	755CK-W0X Use tables W9 and X6	N2
	Adapter retaining ring	All	650ARR-X Use Table X6	-
	600 Series straight receptacle size sensitive kit (cable adapter, retaining ring and lug)	15/25	655CK-W0X-ARR Use tables W7 and X6	N2
	Bushing extender (with stud)	15/25	K655BE	N1, 3
		35	755BE	N1, 3
	Insulated cap with test point (with stud)	15/25	K656DR	N3, 7
		35	756DR	-
	Insulated cap with test point (with stud) and ground	15/25	K656DRG	N3, 7
		35	756DRG	-
	Insulating plug (with cap)	15/25	K650BIP	N1, 7, 8
		35	750BIP	N1, 7, 8
	Grounding plug (ground lead 2/0 AWG x 30")	15/25	650GP	N1, 7, 8
		35	750GP	N1, 7, 8
	Insulated parking bushing	15/25	K650SOP	N7, 8
		35	750SOP	N7, 8
	Connecting plug	15/25	K651CP	N1, 7, 8, 10
		35	750CP	N1, 7, 8, 10
	Deadbreak reducing tap plug	15/25	K650RTP	N1, 7, 8, 9
	Reducing tap well	15/25	K650RTW	N1, 7, 8, 9
	Loadbreak elbow tap plug	15	650ETP	N1, 7, 8, 10
		25	K650ETP	N1, 7, 8, 10
		35	750ETP	N1, 7, 8, 10
	Vault stretcher threaded stud	15/25	650VSA	N1
		35	750VSA	N1
	600 Series elbow threaded stud	15/25	650SA	N1
		35	750SA	N1
	Assembly tool (window-op)	All	600ATM	-
	Spanner wrench	All	600SW	N9
	Direct voltage test meter adapter for: HD electric meters	All	200TC-1	N12
	Ross meters		200TC-2	N12
	Chance meters		200TC-4	N12

**N1.** For 900 A ratings, substitute 675 for 650 and 655; 676 for 656; K671 for K651; K675 for K650 and K655; K676 for K656; 775 for 750 and 755; 776 for 756 and 2X for 0X in the catalog number. The 900 A rating requires copper current-carrying connector components and copper conductor cable.

**N2.** Add suffix symbol from page A17 to include cable shield grounding kit and/or cable jacket sealing kit.

**N3.** Available without the stud by adding "N" to the catalog number.

**N4.** Straight receptacle adapter is used to connect straight receptacles K655YBSR and K655YSR-W0X (page A33) to equipment bushings.

**N5.** Aluminum lug for use on aluminum or copper conductors. DO NOT substitute threaded 03600X lug.

**N6.** Copper lug for use on COPPER CONDUCTOR ONLY. DO NOT substitute threaded 03602X lug.

**N7.** Available with the stud factory-assembled by adding "SP" to the catalog number. 675ETP, K675ETP and 775ETP are available as -SP only. The stud is not field removable.

**N8.** Available with a loose stud by adding suffix "S" to the catalog number.

**N9.** 600SW spanner wrench is recommended for installation of deadbreak reducing tap plugs and reducing tap wells.

**N10.** Use 600ATM assembly tool.  
**N11.** 600 Series elbows and straight receptacles with IEEE Std. 386 capacitive test points are available by substituting 656 for 655; K656 for K655; K676 for K675; 756 for 755; 676 for 675; K676 for K675 and 776 for 775 in the catalog number.

**N12.** Direct test connectors, along with a 200TC-X series meter adapter, a properly rated voltage meter and hot-line stick; provides a means for direct conductor voltage testing.

**N13.** With stainless steel bracket.

**N15.** Available with 200 kV BIL adding suffix "-200".

**N16.** Bimetallic lug for use on aluminum or copper conductors. DO NOT substitute threaded 05501X lug.

Refer to the W and X tables on pages A54–A55 for sizing to cable insulation diameter and conductor size. For cable shield adapters and jacket seals, see pages A44–A45.

## 600 A deadbreak elbow separable connectors

### 600 series deadbreak components

600 series deadbreak elbows, straight receptacles, junctions, vault stretchers and accessories are used to connect equipment and cable on primary feeder and network circuits. Designs accommodate large conductors and feature bolted connections and deadfront modular construction for maximum reliability, performance and versatility.

De-energized connectors can be quickly and easily connected and disconnected using standard hand tools and equipment in accordance with accepted operating practices. Optional accessories allow visible external separation, bypass, isolation, dead-ending, grounding and testing as well as adding taps, surge arresters and circuit protection.

Hotstick operable and separable joint systems are shown on pages A22–A28.

Elastimold junctions are designed for subsurface, vault or padmount applications and can be used for sectionalizing, looping, tapping and equipment bypass. Junctions are designed to mate with other Elastimold products including:

- K655 elbow connector
- K655BE bushing extender
- 655BEA3 bushing adapter

Elastimold junctions are equipped with a stainless steel mounting bracket and back plate suitable for mounting on a flat surface.

### Features

- 15/25 kV and 35 kV, 600 A deadbreak
- 2-Way, 3-way and 4-way junctions
- 200 kV BIL is available for the 35 kV products
- Fully shielded, fully submersible molded rubber housing
- Stainless steel mounting bracket



### Ratings overview

See page A4–A5 for complete information.

#### Current ratings

**(Prefixes: 650, K650, K651, K655, K656, 750, 755, 756 and 03700)**

- 600 A continuous
- 25 kA sym., 10 cycles

**(Prefixes 675, K675, K671, K676, 775, 776 and 03702)**

- 900 A continuous
- 25 kA sym., 10 cycles

Note: 900 A ratings require copper cable and copper current-carrying components.

#### Voltage ratings

**15/25 kV class (5 kV through 28 kV)**

- 16.2 kV phase-to-ground
- 28 kV phase-to-phase
- 140 kV BIL
- 45 kV AC withstand
- 84 kV DC withstand
- 21.5 kV corona extinction

**35 kV class**

- 21.1 kV phase-to-ground
- 36.6 kV phase-to-phase
- 150 kV BIL
- 50 kV AC withstand
- 103 kV DC withstand
- 26 kV corona extinction

Note: Elastimold has increased the IEEE Standard Production and Design Test levels for 25 kV class products to include 27 kV and 28 kV systems.

\* Tested @ 8.3/14.9 kV

† Tested @ 15.2/26.3 kV

• Tested @ 21.1/36.6 kV

# Separable connectors 600 series deadbreak

See pages A104–A113 for surge arrester applications.

Cable to equipment

Cable to cable (using junctions)

Operating accessories

Hotstick operable 600 series connectors See pages A22–A28

Threaded compression lug

Stick-Op loadbreak reducing tap plug

Cam-Op retainer sleeves

Cam-Op link connector

Straight receptacle

Elbow connector

600 Series taps

Cable to cable using L-kits



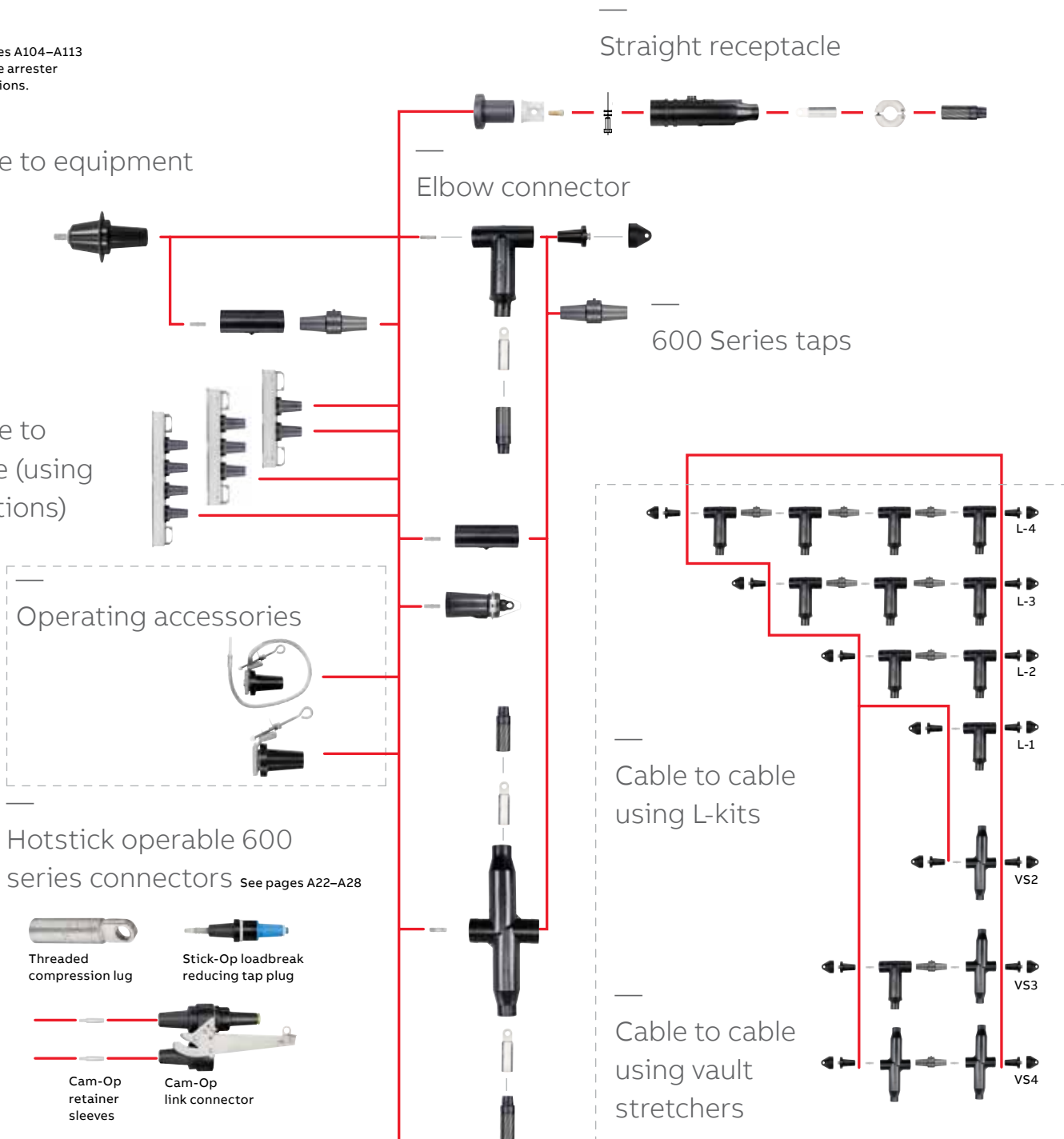







Cable to cable using vault stretchers



## 600 A deadbreak elbow separable connectors

### 600 series deadbreak components

#### 600 series deadbreak components

Image (not to scale)	Description	Voltage class (kV)	Cat. no.	Notes
	2-point junction	15/25 35	K650J2 750J2	N1, 7, 8 N1, 7, 8, 11
	3-point junction	15/25 35	K650J3 750J3	N1, 7, 8 N1, 7, 8, 11
	4-point junction	15/25 35	K650J4 750J4	N1, 7, 8 N1, 7, 8, 11
	1-way L-kit	15/25 35	K655L1 755L1	N1, 2, 3, 9, 10 N1, 2, 3, 11
	2-way L-kit	15/25 35	K655L2-WOX 755L2-WOX	N1, 2, 3, 4, 5, 6, 9, 10 N1, 2, 3, 4, 5, 6, 11
	2-way VS-kit	15/25 kV 35 kV	K655VSL2-WOX 755VSL2-WOX	N1, 2, 3, 9, 10 N1, 2, 3, 11
	3-way L-kit	15/25 35	K655L3-WOX 755L3-WOX	N1, 2, 3, 4, 9, 10 N1, 2, 3, 4, 11
	3-way VS kit	15/25 35	K655VSL3-WOX 755VSL3-WOX	N1, 2, 3, 5, 6, 9, 10 N1, 2, 3, 5, 6, 11
	4-way L-kit	15/25 35	K655L4-WOX 755L4-WOX	N1, 2, 3, 4, 9, 10 N1, 2, 3, 4, 11
	4-way VS-kit	15/25 35	K655VSL4-WOX 755VSL4-WOX	N1, 2, 3, 5, 6, 9, 10 N1, 2, 3, 5, 6, 11
	Assembly tool	All	600ATM	-

- N1.** For 900 A ratings, substitute 675 for 650 and 655; 676 for 656; K675 for K650 and K655; K676 for K656; 775 for 750 and 755; 776 for 756 and 2X for 0X in the catalog number. The 900 A rating requires copper current-carrying connector components and copper conductor cable.
- N2.** L-Kits and VS-Kits do not include cable adapters or compression lugs. These items must be ordered separately.
- N3.** 600 Series Elbows and Straight Receptacles with IEEE Std. 386 capacitive test points are available by substituting 656 for 655; K656 for K655; K676 for K675; 756 for 755; 676 for 675; K676 for K675 and 776 for 775 in the catalog number.
- N4.** 600ATM is recommended for installing K651CP and 750CP.
- N5.** Can be used as a repair joint mounting hardware. (Gains 3/8" of repair length.)
- N6.** Can be used as a reducing joint for different size cables.
- N7.** Rubber junction with stainless steel mounting plate and back plate. Add "-U" for rubber junction with stainless steel mounting plate, back plate and adjustable mounting bracket. Add "-4" for rubber junction only. Add "-5" for rubber junction, stainless steel U-straps and back plate. Add "-6" Hardware package consists of brackets and straps only.
- N8.** Two - six-position multi-point junctions shown on pages A34–A35.
- N9.** Replace "L" for "E" when connecting to equipment and one BIP is not required (i.e., K655E2, K655E3, K655VSE3).
- N10.** Add "G" after "L" to replace a BIP with a GAD + GADDR or "GB" for a BGAD+BGADDR (i.e., K655EG2, K655LGB3, K655VSEG3).
- N11.** Available with 200 kV BIL adding suffix "-200".

Refer to the next page for L-kits and vault stretcher kits ordering information.

## 600 A deadbreak elbow separable connectors

### 600 series Cam-Op™ deadbreak connector system

The Elastimold 600 series Cam-Op deadbreak connector system incorporates provisions for hotstick operation of de-energized primary feeder or network circuits. Configurations allow external visible break, testing, grounding and isolation. Retrofit kits allow upgrading existing equipment.

The Cam-Op system utilizes pin and socket connectors and can be retrofitted to existing equipment. The Cam-Op connector is easily installed or removed by hotstick operation of the cam-action disconnect lever.

#### Features

- 15/25 and 35 kV, 600 A deadbreak-rated Cam-Op link
- Provides 200 A tap for testing and grounding connections
- Cam-Op lever for hotstick operation and easy installation and removal
- Visi-Break series provides for independent isolation of circuits

#### Ratings overview

See pages A4–A5 for complete information.

##### Current ratings

600 A and 900 A continuous  
25 kA sym., 10 cycles

Note: 900 A ratings require copper cable and copper current-carrying components.

##### Continuous voltage ratings

###### 15 kV class

- 8.3 kV phase-to-ground
- 14.4 kV phase-to-phase
- 95 kV BIL
- 34 kV AC withstand
- 53 kV DC withstand
- 11 kV corona extinction

###### 25 kV class

- 15.2 kV phase-to-ground
- 26.3 kV phase-to-phase
- 125 kV BIL
- 40 kV AC withstand
- 78 kV DC withstand
- 19 kV corona extinction

###### 35 kV class

- 21.1 kV phase-to-ground
- 36.6 kV phase-to-phase
- 150 kV BIL
- 50 kV AC withstand
- 103 kV DC withstand
- 26 kV corona extinction







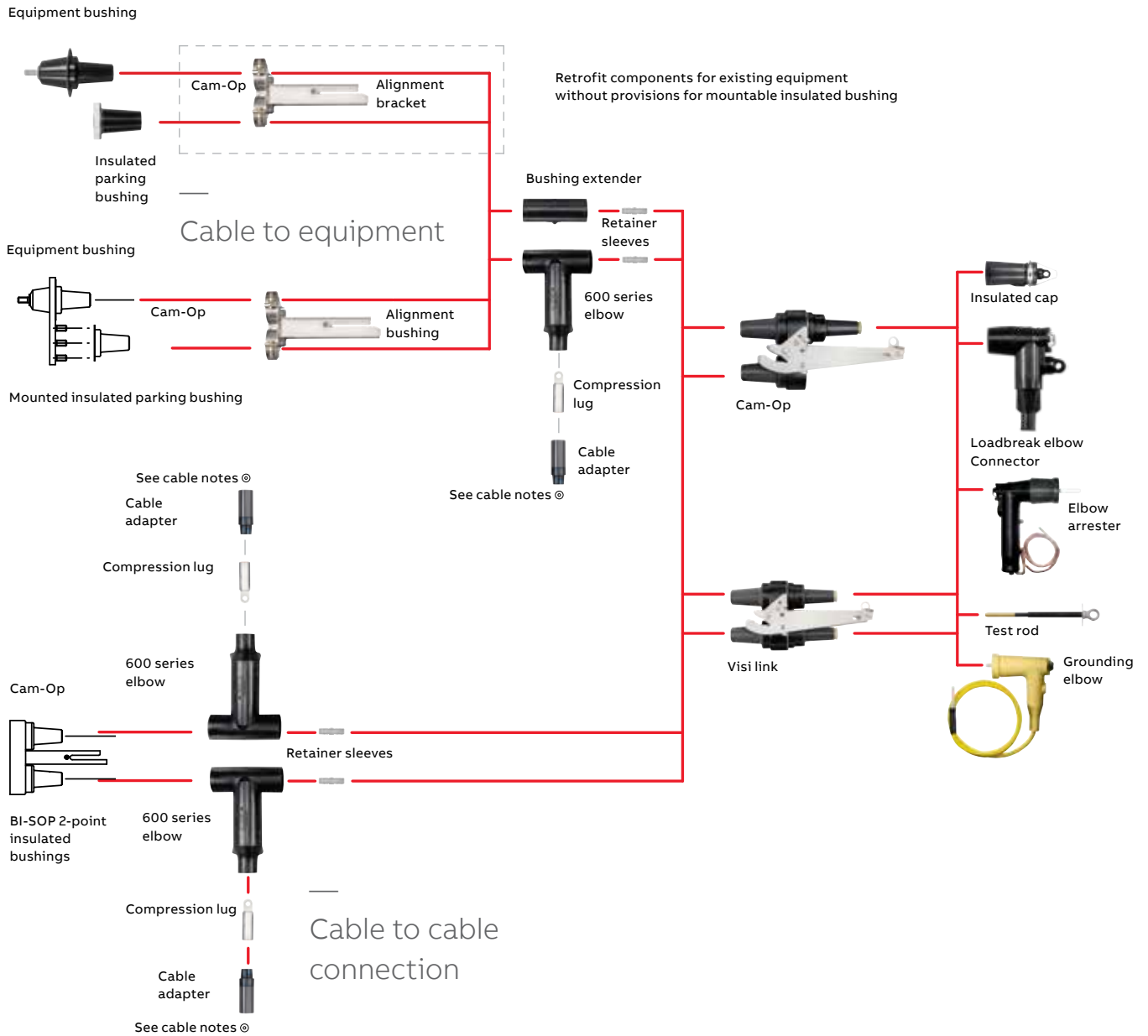









# Cam-Op system – 600 series deadbreak



## 600 A deadbreak elbow separable connectors

### 600 series Cam-Op deadbreak connector system

#### 600 series Cam-Op system

Image (not to scale)	Description	Voltage class (kV)	Cat. no.	Notes
	Cam-Op connector kit	15	655LINK-C-LR-WOX-B-DRG Use tables W7 and X6	N1, 2, 8, 10, 11, 12
		25	K655LINK-C-LR-WOX-B-DRG Use tables W7 and X6	N1, 2, 8, 10, 11, 12
		35	755LINK-C-LR-WOX-B-DRG Use tables W9 and X6	N1, 2, 8, 10, 11, 12
	Mountable insulated bushing	25	K650LBM-3	N2
		35	750LBM-3	N2
	Retrofit Cam-Op connector kit	15	655LINK-C-LR-WOX-A-DRG Use tables W7 and X6	N4, 8, 10, 11, 12
		25	K655LINK-C-LR-WOX-A-DRG Use tables W7 and X6	N4, 8, 10, 11, 12
		35	755LINK-C-LR-WOX-A-DRG Use tables W9 and X6	N4, 8, 10, 11, 12
	Insulating plug	25	K650LB	N3
		35	750LB	N3
	Cam-Op alignment bracket	15	650CAB	–
		25	K650CAB	–
		35	750CAB	–
	Compression lug	All	03700X Use table X6	N5
			03702X Use table X6	N6
			04601X	–
	Cam-Op size sensitive kit (cable adapter and lug)	15/25	655CK-WOX Use tables W7 and X6	N10
		35	755CK-WOX Use tables W9 and X6	N10
	Cam-Op retaining sleeve	All	650RSC	N8
	Cam-Op cable joint kit	15	655BI-LINK-C-LR-WOX-DRG Use tables W7 and X6	N7, 8, 10, 11, 12
		25	K655BI-LINK-C-LR-WOX-DRG Use tables W7 and X6	N7, 8, 10, 11, 12
		35	755BI-LINK-C-LR-WOX-DRG Use tables W9 and X6	N7, 8, 10, 11, 12
	Cam-Op loadbreak reducing tap plugs (visi-break)	15	650LK-C-VB	–
		25	K650LK-C-VB	–
		35	750LK-C-VB	–
	Cam-Op link	15	650LK-C	–
		25	K650LK-C	–
		35	750LK-C	–
	Grounding elbow (1/0 AWG x 6' ground lead)	15	160GLR	–
		25	370GLR	N 13
		35	370GLR	N 13
	Test rod	All	370TR	–

**N1.** Cam-Op connector kit includes: (1) Cam-Op link; (1) elbow housing; (1) cable adapter; (1) 0370 style lug; (1) bushing extender; (2) retainer sleeves; (1) insulated cap; (1) mountable insulated bushing and (1) alignment bracket.

**N2.** Mountable insulated bushing included with Cam-Op connector kit. Requires three threaded studs on equipment faceplate for installation.

**N3.** Use with the retrofit Cam-Op connector kit.

**N4.** Retrofit Cam-Op connector kit includes: (1) link; (1) elbow housing; (1) cable adapter; (1) 0370 style lug; (1) bushing extender; (2) retainer sleeves; (1) insulated cap; (1) insulating plug; and (1) alignment bracket.

**N5.** Aluminum lug for use on aluminum or copper conductors. DO NOT substitute threaded 03600X lug.

**N6.** Copper lug for use on COPPER CONDUCTOR ONLY.

DO NOT substitute 03602X threaded lug.

**N7.** Cam-Op cable joint kit includes: (1) Cam-Op link; (1) Cam-Op BI-SOP; (2) elbow housings; (2) cable adapters; (2) 0370 style lugs; (2) retainer sleeves; (1) insulated cap.

**N8.** 600ATM is recommended for installing Cam-Op retaining sleeves.

**N9.** For 900-amp ratings, substitute 675 for 650 and 655; 676 for 656; K675 for K650 and K655; K676 for K656; 775 for 750 and 755; 776 for 756 and 2X for 0X in the catalog number. The 900-amp rating requires copper current-carrying connector components and copper conductor cable.

**N10.** Add suffix symbol from page A17 to include cable shield grounding kit and/or cable jacket sealing kit.

**N11.** To add elbows or arresters instead of insulating caps, replace the "DRG" with "LR-WX" for elbows (with test point) or "ESA" for elbow arresters.

**N12.** 600 series elbows with IEEE 386 capacitive test points are available by substituting 656 for 655; K656 for K655; K676 for K675; 756 for 755; 676 for 675; K676 for K675 and 776 for 775 in the catalog number.

**N13.** Rated for both 25 kV and 35 kV applications.

Refer to the W and X tables on pages A54–A55 for sizing to cable insulation diameter and conductor size. For cable shield adapters and jacket seals, see pages A44–A45.

## 600 series test and ground and Stick-Op™ deadbreak connector systems

The Elastimold 600 series test and ground and Stick-Op deadbreak connector systems incorporate provisions for hotstick operation of de-energized primary feeder or network circuits.

The test and ground and Stick-Op connectors allow direct testing and grounding with no required cable movement.

Test and ground is ideal for equipment applications that include viewing windows to provide an internal visible break and that do not require hotstick removal of the elbows.

Stick-Op provides an external visible break by hotstick removal of the elbow.

Test and ground and Stick-Op connectors are bolted and installed using torque-controlled tools.

### Ratings overview

See pages A4–A5 for complete information.

#### Current ratings

- 600 A and 900 A continuous
- 25 kA sym., 10 cycles

Note: 900 A ratings require copper cable and copper current-carrying components.

#### Continuous voltage ratings

##### 15 kV class

- 8.3 kV phase-to-ground
- 14.4 kV phase-to-phase
- 95 kV BIL
- 34 kV AC withstand
- 53 kV DC withstand
- 11 kV corona extinction

##### 25 kV class

- 15.2 kV phase-to-ground
- 26.3 kV phase-to-phase
- 125 kV BIL
- 40 kV AC withstand
- 78 kV DC withstand
- 19 kV corona extinction

##### 35 kV class

- 21.1 kV phase-to-ground
- 36.6 kV phase-to-phase
- 150 kV BIL
- 50 kV AC withstand
- 103 kV DC withstand
- 26 kV corona extinction



### 600 A deadbreak elbow separable connectors

600 series test and ground and Stick-Op deadbreak connector systems

Stick-Op and test and ground system – 600 series deadbreak



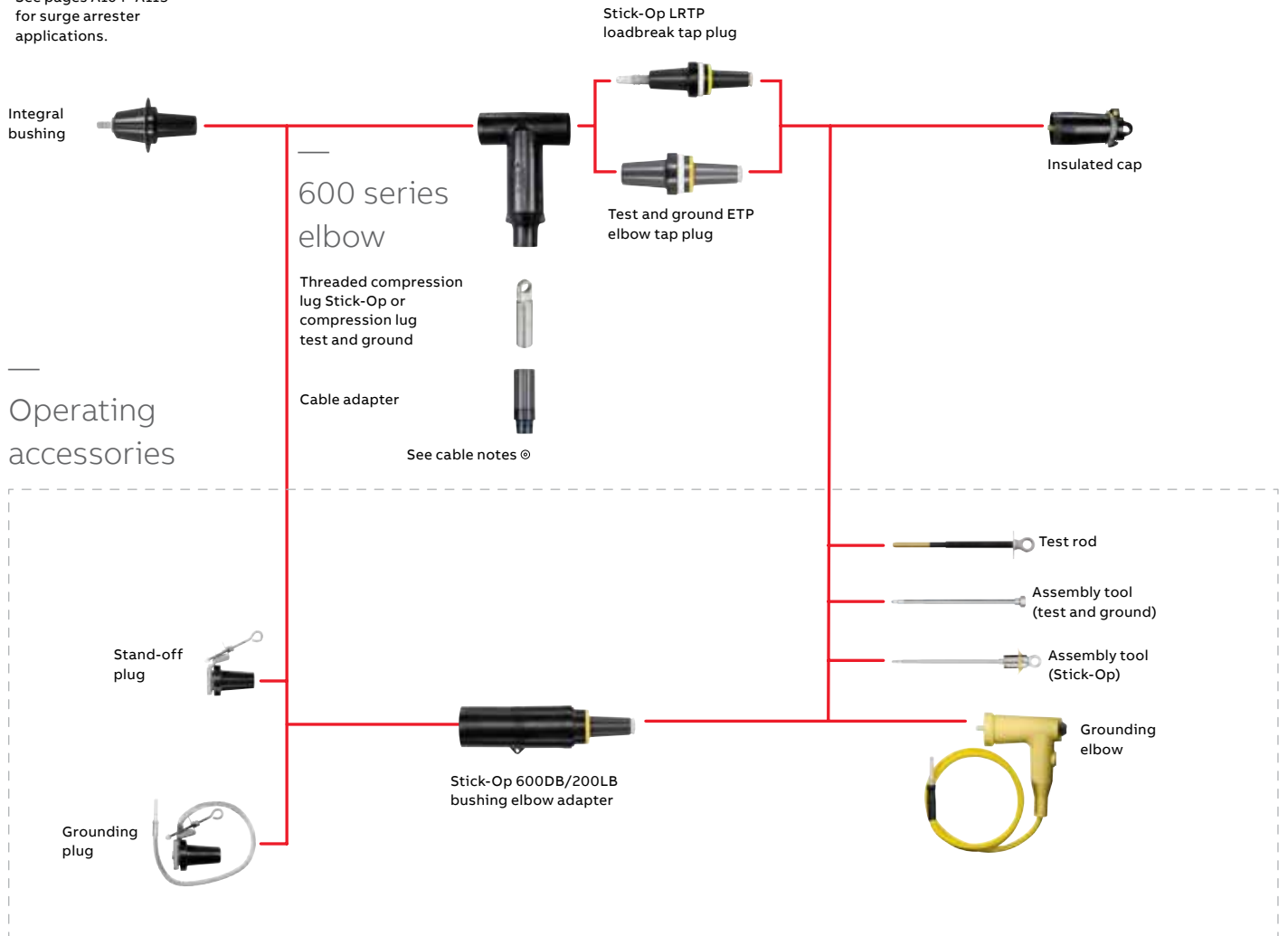

See pages A104–A113 for surge arrester applications.



## 600 A deadbreak elbow separable connectors

### Stick-Op kits













#### Stick-Op kits

Image (not to scale)	Description	Voltage class (kV)	Cat. no.	Notes
	Test and ground connector kit	15	655ETP-WOX-DRG Use tables W7 and X6	N1, 4, 5, 6, 11, 13
		25	K655ETP-WOX-DRG Use tables W7 and X6	
		35	755ETP-WOX-DRG Use tables W9 and X6	
	Test and ground replacement connector kit	15	655RETP	N4, 5, 6, 11, 13, 14
		25	K655RETP	
	Stick-Op connector kit	15	655LRTP-WOX-DRG Use tables W7 and X6	N2, 3, 4, 5, 8, 11
		25	K655LRTP-WOX-DRG Use tables W7 and X6	
		35	755LRTP-WOX-DRG Use tables W9 and X6	
	Stick-Op replacement connector kit	15	655RLRTP	N3, 4, 5, 8, 11, 14
		25	K655RLRTP	

## 600 A deadbreak elbow separable connectors

600 series test and ground and Stick-Op deadbreak connector systems

### Stick-Op accessories

Image (not to scale)	Description	Voltage class (kV)	Cat. no.	Notes
	Stick-Op size-sensitive kit (cable adapter and threaded lug)	15/25	655TCK-WOX Use tables W7 and X6	N5
		35	755TCK-WOX Use tables W9 and X6	N5
	Extraction tool	All	650ET	N10
	Grounding elbow (1/0 AWG x 6' ground lead)	15	160GLR	-
		25	370GLR	N12
		35	370GLR	N12
	Test rod	All	370TR	-
	Assembly tool (Stick-Op)	All	600AT	N3
	Assembly tool (test and ground)	All	600ATM	N13
	Test and ground loadbreak elbow tap plug	15	650ETP	N4, 13, 16
		25	K650ETP	N4, 13, 16
		35	750ETP	N4, 13, 16
	Stick-Op loadbreak reducing tap plug	15	650LRTPA3	N3, 4
		25	K650LRTPA2	-
		35	750LRTPA2	-
	Stick-Op bushing adapter	15	655BEA3	N3, 4
		25	K655BEA2	-
		35	755BEA2	-
	Compression lug test and ground	All	03700X Use tables X6	N6
		All	03702X Use tables X6	N7
	Threaded compression lug Stick-Op	All	03600X Use tables X6	N8, 15
		All	03602X Use tables X6	N9
	Test and ground size-sensitive kit (cable adapter and lug)	15/25	655CK-WOX Use tables W7 and X6	N4, 5
		35	755CK-WOX Use tables W9 and X6	N4, 5

**N1.** Test and ground kit includes: insulated cap; test and ground reducing tap plug; 600 series elbow housing; cable adapter; and 0370 style compression lug.

**N2.** Stick-Op kit includes insulated cap; Stick-Op loadbreak reducing tap plug; 600 series elbow housing; cable adapter; and threaded 0360 style compression lug.

**N3.** 600AT assembly tool required for operation and/or installation of Stick-Op.

**N4.** For 900 A ratings, substitute 675 for 650 and 655; 676 for 656; K675 for K650 and K655; K676 for K656; 775 for 750 and 755; 776 for 756 and 2X for 0X in the catalog number. The 900 A rating requires copper current-carrying connector components and copper conductor cable.

**N5.** Add suffix symbol from page A17 to include cable shield grounding kit and/or cable jacket sealing kit.

**N6.** Aluminum lug for use on aluminum or copper conductors.

DO NOT substitute threaded 03600X lug.

**N7.** Copper lug for use on COPPER CONDUCTOR ONLY.

DO NOT substitute 03602X threaded lug.

**N8.** Threaded aluminum lug (Stick-Op only) for use on copper or aluminum conductors. DO NOT substitute unthreaded 03700X lugs. DO NOT use with 675, 676, K675, K676, 775 or 776 catalog numbers.

**N9.** Threaded copper lug (Stick-Op only) for use on copper conductors only. DO NOT substitute unthreaded 03702X lugs.

**N10.** Required to disassemble Stick-Op loadbreak reducing tap plug from the threaded compression lug and 600 series elbow after the shear-pin is broken during assembly.

**N11.** 600 series Elbows with IEEE 386 capacitive test points are available by substituting 656 for 655; K656 for K655; K676 for K675; 756 for 755; 676 for 675; K676 for K675 and 776 for 775 in the catalog number.

**N12.** Rated for both 25 kV and 35 kV applications.

**N13.** 600ATM assembly tool required for test and ground assembly. 50–60 ft./lbs. torque wrench required but not included.

**N14.** Replacement elbow includes: insulated cap; reducing tap plug; 600 series elbow housing; I-adapter; straight receptacle, resulting in a net gain of 20" in length vs. a standard elbow kit. Compression lugs and cable adapters are ordered separately.

**N15.** Retrofit sleeve to convert 03600X series lug to a 03700X series lug (catalog number 650-353).

**N16.** Add "SP" to the part number to include factory-assembled stud.

Refer to the W and X tables on pages A54–A55 for sizing to cable insulation diameter and conductor size. For cable shield adapters and jacket seals, see pages A44–A45.

## 600 A separable cable joints

600 series separable cable joints are available in 2-, 3- and 4-way versions and include a capacitive test point as standard. Units are interchangeable, featuring bolted connections. Designs are compact and ideally suited for small vaults and manholes.

De-energized joints can be quickly and easily connected and disconnected using standard hand tools and equipment in accordance with accepted operating practices. Bus bars can be changed to add or remove cables from the joint.

Optional accessories include insulating and grounding caps and plugs which allow visible external separation, bypass, isolation, dead-ending, grounding and testing.

### Ratings overview

See page A17 for complete information.

#### Current ratings

- (Prefixes: 650, K650, K655, K656 & 03700)
- 600 Amp Continuous
- 25kA sym., 10 cycles

#### Voltage ratings

- 15/25 kV class (5kV thru 28kV)
- 16.2 kV phase-to-ground
- 28 kV phase-to-phase
- 140 kV BIL
- 45 kV AC withstand
- 84 kV DC withstand
- 21.5 kV corona extinction

Note: Elastimold has increased the IEEE standard production and design test levels for 25 kV Class products to include 27 kV and 28 kV systems.



## Separable cable joints – 600 series deadbreak

- 01 Separable H-joint (4-way)
- 02 Separable wye-joint (3-way)
- 03 Separable straight joint (2-way)

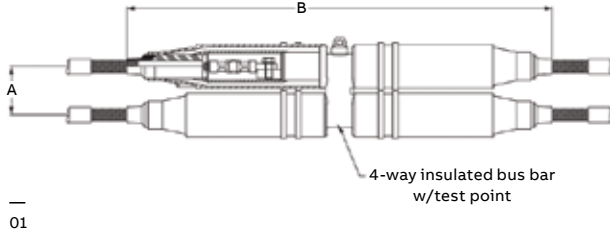

Dimension	Inches
A	4¼
B	37½
C	8⅛
D	3⅞

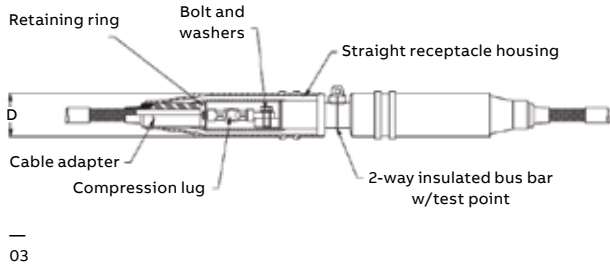
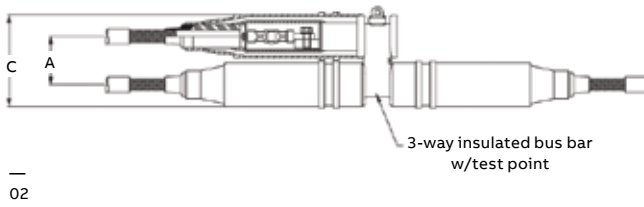

### Operating accessories

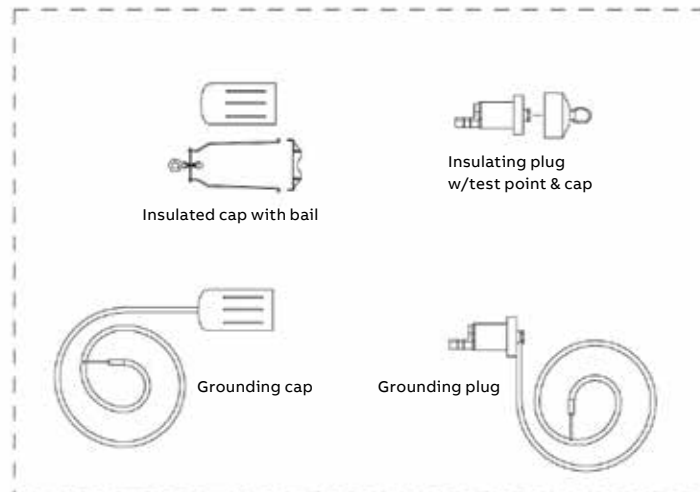

Note: The separable cable joints shown here use a special "Y" interface that may not be interchangeable with other 600 Series interfaces.



## 600 A separable cable joints

### 600 A separable cable joints

Illustration (not to scale)	Description	Voltage class	Cat. no.	Notes
	Separable straight joint pkg. (2-Way) w/ test point	15/25 kV	K656I-WOX Use tables W7 and X6	N1, 8
	Basic housing pkg. Straight joint w/ test point	15/25 kV	K656I-HP	N2
	Separable wye joint pkg. (3-Way) w/ test point	15/25 kV	K656CY-WOX Use tables W7 and X6	N1, 8
	Basic housing pkg. Wye joint w/test point	15/25 kV	K656CY-HP	N2
	Separable "H" joint pkg. (4-Way) w/ test point	15/25 kV	K656CH-WOX Use tables W7 and X6	N1, 8
	Basic housing pkg. "H" joint w/test point	15/25 kV	K656CH-HP	N2
	2-Way insulated bus bar w/test point	15/25 kV	K656I-BUS	N3
	3-Way insulated bus bar w/test point	15/25 kV	K656CY-BUS	N3
	4-Way insulated bus bar w/test point	15/25 kV	K656CH-BUS	N3
	Straight receptacle	15/25 kV	K655YSR-WOX Use tables W7 and X6	N4, 8
	Direct test straight receptacle elbow	15/25 kV	K656YDSR-WOX Use tables W7 and X6	N4, 8, 11
	Direct test straight receptacle elbow w/test point	15/25 kV	K656YDSR-WOX Use tables W7 and X6	N4, 8, 11
	Straight receptacle housing only	15/25 kV	K655YBSR	N5, 10
	Insulated cap w/ bail	15/25 kV	K655YDR	
	Bail only	15/25 kV	650BA	
	Cable adapter	15/25 kV	655CA-W Use Table W7	
	Adapter retaining ring	15/25 kV	650ARR-X	
	Compression lug	15/25 kV 15/25 kV	03700X 03702X use table X6	N7 N9

Illustration (not to scale)	Description	Voltage class	Cat. no.	Notes
	600 Series straight receptacle size sensitive kit (cable adapter, retaining ring and lug)	15/25 kV	655CK-WOX-ARR use tables W7 and X6	N8
	Insulating plug w/Test point and cap	15/25 kV	K650YBIP	
	Grounding plug (4/0 awg x 6' Ground lead)	15/25 kV	650YGP	
	Grounding cap (4/0 awg x 6' ground lead)	15/25 kV	650GYDR	
	Stainless steel bolt and washers	15/25 kV	650BAW	
	Assembly/disassembly tool	All	600YADT-1	N6
	Assembly/disassembly tool	All	600RRT	N6

Refer to the W and X tables on pages A54-A55 for sizing to cable insulation diameter and conductor size. For cable shield adapters and jacket seals, see pages A44-A45.

- N1.** Complete joint packages consisting of: insulated bus bar, straight receptacle housings, retaining rings, cable size adapters, lugs, bolts and washers.
- N2.** Housing packages consisting of the following non-size sensitive components of the joint: insulated bus bar, straight receptacle housings, bolts and washers.
- N3.** Insulated bus bar only.
- N4.** Straight receptacle consisting of: straight receptacle housing, retaining ring, cable adapter, lug, bolt and washers.
- N5.** Straight receptacle housing consisting of: straight receptacle housing, bolt and washers.
- N6.** Recommended for ease of assembly/disassembly of receptacles to Bus. 600YADT-1 is lever drive and 600RRT is screw drive.
- N7.** Aluminum lug for use on aluminum or copper conductors. DO NOT substitute threaded 03600X lug.
- N8.** Add suffix symbol from page A17 to include cable shield grounding kit and/or cable jacket sealing kit.
- N9.** Copper lug for use with COPPER CONDUCTOR ONLY. DO NOT substitute threaded 03602X lug.
- N10.** Available without the bolt and washers by adding "N" to the part number.
- N11.** Direct Test Connectors, along with a 200TC-X series meter adapter, a properly rated voltage meter and Hot-line Stick, provides a means for direct conductor voltage testing. See pages A10, A15 and A19 for meter adapters.

## Multi-point junctions

### Molded multi-point junctions

—  
01 J6-622226-25  
—  
02 J6-662266-25-SV

Elastimold multi-point junctions are available in 2-, 3-, 4-, 5- or 6-point configurations with 15, 25/28 or 35 kV ratings. Units feature modular design flexibility, allowing selection of any combination of 200 A deepwell or 600 A bushing interfaces located on standard 4" or optional 6½" centers. The 6½" center spacing is especially well suited for distributed switchgear applications, including fused elbow, MVI fault interrupter, MVS switch, etc.

Designs incorporate lightweight, damage-resistant, EPDM molded rubber construction and corrosion-resistant 304 stainless steel mounting brackets. Junctions are maintenance free, fully shielded, deadfront and submersible. Units are ideally suited for subsurface, padmount, indoor and outdoor vault applications.

Elastimold multi-point junctions provide a convenient method for connecting, looping and tapping of 200 A and 600 A elbows and other accessories at a common location where utilization of space, cable training, flexibility and operability are important.

### Features

- 15/25/35 kV, 200/600 A molded multipoint junctions
- Fully shielded, fully submersible molded rubber housing
- Uses 304 stainless steel for brackets to prevent rusting and corrosion
- Provides mating for Elastimold elbow connectors, both 600 A and 200 A
- Increases flexibility and operational ability by saving space in crucial areas
- Optional bails available for 200 A deadbreak application



—  
01

### Ratings overview

See pages A4–A5 for complete information

#### Current ratings

- 600 A continuous
- 25 kA sym., 10 cycles

#### Or with 200-amp bushing well versions

- 200 A continuous
- 10 kA sym., 10 cycles

#### Voltage ratings

##### 15 kV class

- 8.3 kV phase-to-ground
- 95 kV BIL
- 34 kV AC withstand
- 53 kV DC withstand
- 11 kV corona extinction

##### 25/28 kV class

- 16.2 kV phase-to-ground
- 140 kV BIL
- 45 kV AC withstand
- 84 kV DC withstand
- 21.5 kV corona extinction

##### 35 kV class

- 21.1 kV phase-to-ground
- 150 kV BIL
- 50 kV AC withstand
- 103 kV DC withstand
- 26 kV corona extinction



—  
02

# Multi-point junctions

## Molded multi-point junctions

01 Figure 1: Multi-point junctions with 4" interface spacings.

02 Figure 2: Multi-point junctions with 6½" interface spacings.

### Dimensional information

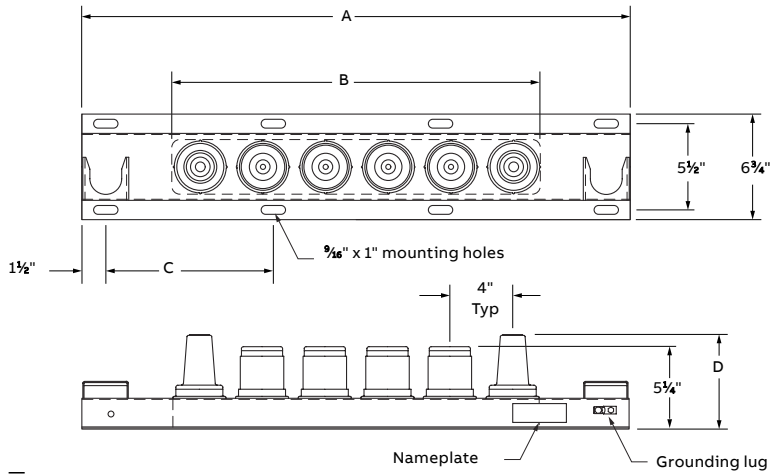

01

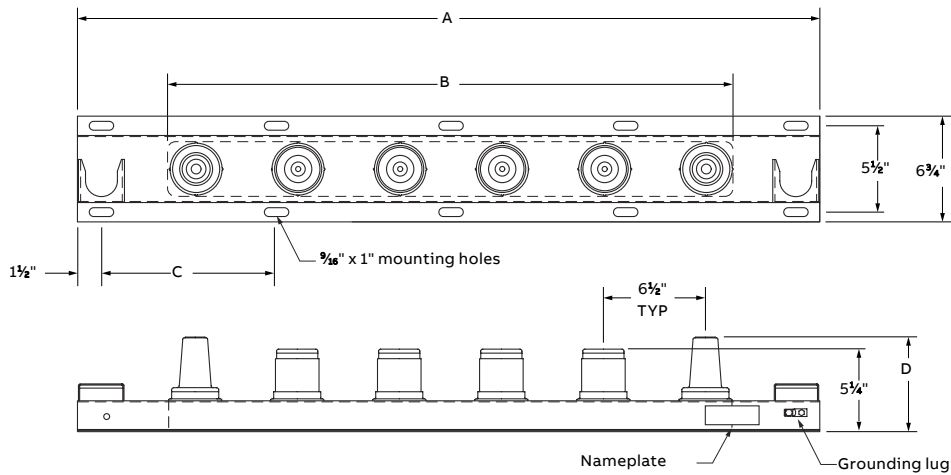

02

Type of junction	Figure 1				Figure 2			
	Dimensions (in.)			Number of mounting holes	Dimensions (in.)			Number of mounting holes
A	B	C	A		B	C		
J2	15	7½	6	6	19½	10	8¾	6
J3	19	11½	8	6	26	16½	11½	6
J4	24	15½	10	6	32½	23	9¾	8
J5	27	19½	12	6	39	29½	12	8
J6	31	23½	9¾	8	45½	36	8¾	10

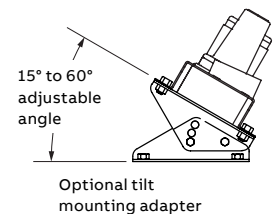







## Multi-point junctions

### Molded multi-point junctions

Elastimold multi-point junctions feature modular design flexibility that permits the specifier to determine the positions of the bushing interfaces and bushing well positions.

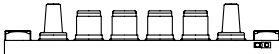
#### Base catalog numbers

Image (not to scale)	Description	Voltage class (kV)	Cat. no.		Notes
			4" spacing	6½" spacing	
	2-point junction	15	J2 - ____ - 15	J2 - ____ - 15-SV	N1, 2
		25/28	J2 - ____ - 25	J2 - ____ - 25-SV	
		35	J2 - ____ - 35	J2 - ____ - 35-SV	
	3-point junction	15	J3 - _____ - 15	J3 - _____ - 15-SV	N1, 2
		25/28	J3 - _____ - 25	J3 - _____ - 25-SV	
		35	J3 - _____ - 35	J3 - _____ - 35-SV	
	4-point junction	15	J4 - _____ - 15	J4 - _____ - 15-SV	N1, 2
		25/28	J4 - _____ - 25	J4 - _____ - 25-SV	
		35	J4 - _____ - 35	J4 - _____ - 35-SV	
	5-point junction	15	J5 - _____ - 15	J5 - _____ - 15-SV	N1, 2
		25/28	J5 - _____ - 25	J5 - _____ - 25-SV	
		35	J5 - _____ - 35	J5 - _____ - 35-SV	
	6-point junction	15	J6 - _____ - 15	J6 - _____ - 15-SV	N1, 2
		25/28	J6 - _____ - 25	J6 - _____ - 25-SV	
		35	J6 - _____ - 35	J6 - _____ - 35-SV	
	5-point junction	25/28	J5 - 66666 - 25CU	-	N2, 3
		35	J5 - 66666 - 35CU		
	6-point junction	25/28	J6 - 666666 - 25CU	-	N2, 3
		35	J6 - 666666 - 35CU		

**N1.** The 6½" wide spacing is necessary if the junction is to be used to connect with a single-phase MVS molded vacuum switch or MVI molded vacuum interrupter.

**N2.** Also available with a shorter bracket by reducing the number of parking stands; see R, L, N in options.

**N3.** Copper conductor for 900 A rating. Use suffix "CU" at the end of the catalog number.

## Multi-point junctions

### Ordering information

To specify and order Elastimold multi-point junctions: Use Table 1 to construct a catalog number describing the required junction.

#### Ordering example A

To order a 4-point, 15 kV junction with 4" spacings and 600 series interfaces on the outside ways and 200 A wells on the inside ways, specify catalog number J4-6226-15.

#### Ordering example B

To order a 6-point, 25/28 kV junction with 6½" spacings and 600 series interfaces on ways 1, 3, 4 and 6 and 200 A wells on the ways 2 and 5, specify catalog number J6-626626-25-SV.

Table 1. Catalog number construction

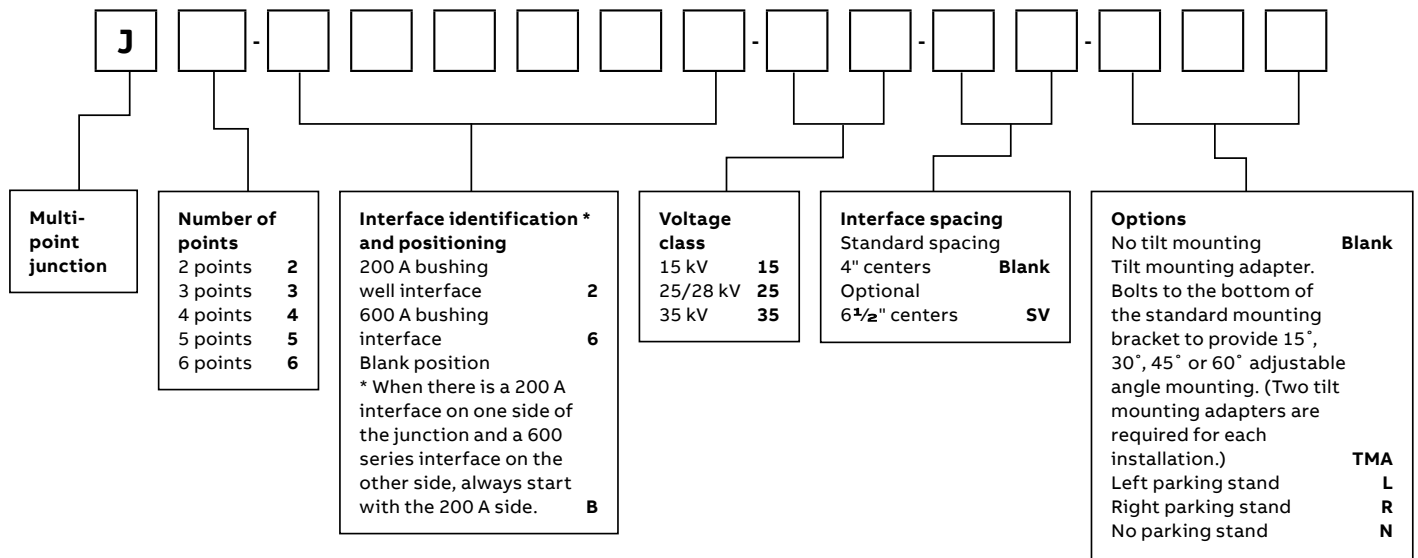

## Permanent distribution cable joints

### PCJ power cable joints

PCJ power cable joints use permanently crimped connectors. PCJ housings are fully insulated, shielded and sealed for direct-burial, vault, submersible and other severe service applications. Units have been designed and tested per IEEE Standard 404 to ensure system-matched performance and ratings equal to the cable to which the splice will be installed.

#### PCJ power cable joints are available in two styles:

Style 1 uses a single-piece housing that is sized to accommodate a specific range of cable. Style 1 units are ideally suited for straight splicing of the same or similar cable.

Style 2 designs incorporate a universal housing with separate cable adapters to allow transition splices of different types and sizes of cable.

### Electrical ratings summary

The following ratings summary is based on IEEE 404 and applies to all Elastimold PCJ power cable joints.

#### Voltage

- A. 15 kV class (8.7 kV phase-to-ground)
- B. 25 kV class (14.4 kV phase-to-ground)
- C. 35 kV class (20.2 kV phase-to-ground)
- Impulse withstand: A = 110 kV, B = 150 kV, C = 200 kV BIL, 1.2 x 50 microsecond wave
- Corona extinction voltage: A = 13 kV, B = 22 kV, C = 30 kV minimum, 3 pC sensitivity
- DC withstand: During installation, A = 56 kV, B = 80 kV, C = 100 kV
- DC withstand: After installation and in service for the first 5 years, A = 18 kV, B = 25 kV, C = 31 kV for XLPE insulated cables and A = 45 kV, B = 64 kV, C = 80 kV for EPR insulated cables (reference AEIC CS6 and CS8, Section L.2)

#### Current

Continuous rating equal to the rating of the cable  
Short-time rating equal to the rating of the cable up to 35 kA

#### Shield design

- Meets IEEE 592 for exposed semiconducting shields on premolded high voltage cable joints and separable insulated connectors

#### Production tests include 100% tests of the premolded joints to ensure:

- Corona extinction voltage: A = 13 kV, B = 22 kV, C = 30 kV minimum, 3 pC sensitivity
- AC withstand: A = 35 kV, B = 52 kV, C = 69 kV, 60 Hz, 1 minute

#### Design tests on production joints demonstrate compliance with IEEE 404 including:

- Corona extinction voltage: A = 13.0 kV, B = 22.0 kV, C = 30.0 kV minimum, 3 pC sensitivity
- AC withstand: A = 35 kV, B = 52 kV, C = 69 kV, 60 Hz, 1 minute
- DC withstand: A = 75 kV, B = 105 kV, C = 140 kV negative polarity, 15 minutes
- Impulse withstand (BIL): A = 110 kV, B = 150 kV, C = 200 kV, 10 positive and 10 negative, 1.2 x 50 microsecond wave, at conductor temperatures of 20 °C and 130 °C, nominal
- Short-time current: Magnitude equal to cable up to 35 kA
- Cyclic aging: 30 days at A = 26 kV, B = 43 kV, C = 61 kV AC continuous, load current for 8 hours per day, providing 130 °C conductor temperature; joints then subjected to A = 31 kV, B = 50 kV, C = 71 kV for 5 hours followed by A = 39 kV, B = 65 kV, C = 91 kV for 5 min
- Load cycle: Connectors meet requirements of ANSI C119.4, Class A and Class 3 ratings

## Permanent distribution cable joints

### PCJ power cable joints

#### PCJ style 1

With single-piece housing

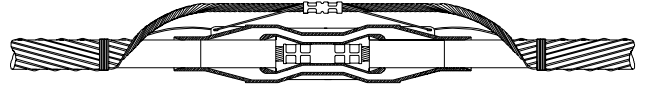

#### PCJ style 2

With universal housing and separate cable adapters that can be varied with the cable application

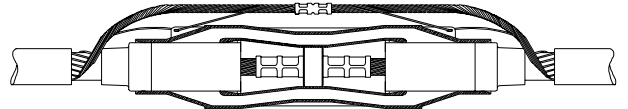

#### Ordering information

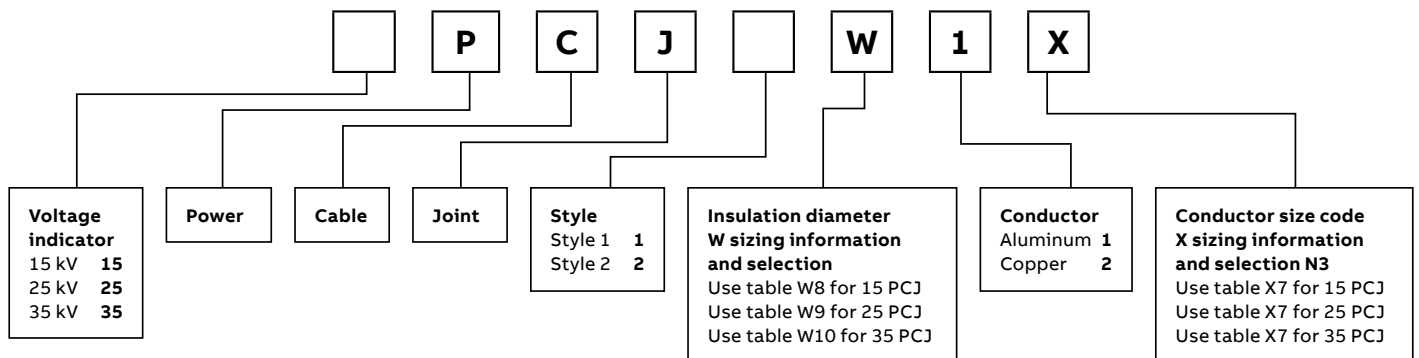

## Permanent distribution cable joints

### PCJ power cable joints

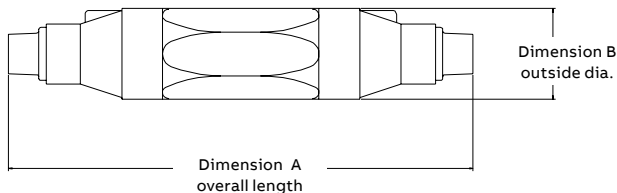

#### Dimensional data

Style 1 Cat. no.	A inches	B inches
15PCJ1FX	10 <sup>3</sup> / <sub>4</sub>	1 <sup>3</sup> / <sub>4</sub>
15PCJ1GX	10 <sup>3</sup> / <sub>4</sub>	1 <sup>3</sup> / <sub>4</sub>
25PCJ1GX	14 <sup>3</sup> / <sub>8</sub>	2 <sup>7</sup> / <sub>16</sub>
15/25/35PCJ1HX	14 <sup>3</sup> / <sub>8</sub>	2 <sup>7</sup> / <sub>16</sub>
15/25/35PCJ1JX	14 <sup>3</sup> / <sub>8</sub>	2 <sup>7</sup> / <sub>16</sub>
15/25/35PCJ1KX	14 <sup>3</sup> / <sub>8</sub>	2 <sup>25</sup> / <sub>32</sub>
15/25/35PCJ1LX	14 <sup>3</sup> / <sub>8</sub>	2 <sup>25</sup> / <sub>32</sub>
15/25PCJ1LMX	14 <sup>3</sup> / <sub>8</sub>	2 <sup>25</sup> / <sub>32</sub>
15/25/35PCJ1MX	14 <sup>3</sup> / <sub>8</sub>	2 <sup>25</sup> / <sub>32</sub>
15/25/35PCJ1NX	15 <sup>3</sup> / <sub>4</sub>	3 <sup>3</sup> / <sub>16</sub>
15/25/35PCJ1PX	15 <sup>3</sup> / <sub>4</sub>	3 <sup>3</sup> / <sub>16</sub>
15/25/35PCJ1QX	15 <sup>3</sup> / <sub>4</sub>	3 <sup>3</sup> / <sub>16</sub>

#### PCJ power cable joint

Description	Voltage class (kV)	Cat. no.	Notes
Power cable joint Style 1	15	15PCJ1W1X	N1
	15	15PCJ1W2X	N2
	25	25PCJ1W1X	N1
	25	25PCJ1W2X	N2
	35	35PCJ1W1X	N1
	35	35PCJ1W2X	N2
Power cable joint Style 2	15	15PCJ2W1X	N1
	15	15PCJ2W2X	N2
	25	25PCJ2W1X	N1
	25	25PCJ2W2X	N2
	35	35PCJ2W1X	N1
	35	35PCJ2W2X	N2

#### Dimensional data

Style 2 Cat. no.	A inches	B inches
15PCJ2FX	16 <sup>3</sup> / <sub>8</sub>	2 <sup>25</sup> / <sub>32</sub>
15/25PCJ2GX	16 <sup>3</sup> / <sub>8</sub>	2 <sup>25</sup> / <sub>32</sub>
15/25/35PCJ2HX	16 <sup>3</sup> / <sub>8</sub>	2 <sup>25</sup> / <sub>32</sub>
15/25/35PCJ2JX	16 <sup>3</sup> / <sub>8</sub>	2 <sup>25</sup> / <sub>32</sub>
15/25/35PCJ2KX	21	3 <sup>3</sup> / <sub>4</sub>
15/25/35PCJ2LX	21	3 <sup>3</sup> / <sub>4</sub>
15/25/35PCJ2MX	21	3 <sup>3</sup> / <sub>4</sub>
15/25/35PCJ2NX	21	3 <sup>3</sup> / <sub>4</sub>
15/25/35PCJ2PX	21	3 <sup>3</sup> / <sub>4</sub>
15/25/35PCJ2QX	21	3 <sup>3</sup> / <sub>4</sub>

**N1.** Kit includes aluminum compression connector suitable for splicing aluminum conductor to aluminum conductor or aluminum conductor to copper conductor.

An all-copper connector is required for copper-to-copper connections.

**N2.** Kit includes copper compression connector suitable for splicing copper conductors to copper conductor only. DO NOT use copper connectors on aluminum conductors.

**N3.** When constructing a catalog number for a transition (two different-size cables) joint, list the larger connector first and the smaller connector second.

Refer to the W and X tables on pages A54–A55 for sizing to cable insulation diameter and conductor size. For cable shield adapters and jacket seals, see pages A44–A45.



## Pre-molded terminations

### Cable terminations

Elastimold cable terminations are available in a single-piece design. Terminators allow connection and transition from shielded, underground cable to bare overhead conductors and live-front equipment. Units are designed and rated per IEEE 48 for riser pole, padmount, indoor and outdoor applications. PCT1 and PCT2 terminators provide sufficient creep, strike and weather sealing for Class 1 outdoor service. PCT1 and PCT2 also include an integral cable jacket seal.

#### Voltage ratings

##### 15 kV class

- 9.5 kV phase-to-ground
- 110 kV BIL 1.2 x 50 microsecond wave
- AC withstand:
  - 50 kV 1 min. – Dry
  - 35 kV 6 hr. – Dry
  - 45 kV 10 sec. – Wet
- 13 kV corona extinction

##### 25 kV class

- 16 kV phase-to-ground
- 150 kV BIL 1.2 x 50 microsecond wave
- AC withstand:
  - 65 kV 1 min. – Dry
  - 55 kV 6 hr. – Dry
  - 60 kV 10 sec. – Wet
- 21.5 kV corona extinction

### Electrical ratings summary

The following ratings summary is based on IEEE Standard 48 and applies to all the terminations on this page. Elastimold terminations are designed for use on three-phase systems, either 3-wire or 4-wire, and the single-phase laterals of these systems.

#### Cable terminations

	Description	Voltage class (kV)	Cat. no.	Notes
	Single-piece terminator (class 1)	15	PCT1-1X-4 Use table X9	N2, 3, 4, 5
		25	PCT2-1X-4 Use table X9	N2, 3, 4, 6
	Housing only	15	PCT1-4	N5
		25	PCT2-4	N6
	Rod contact for PCT	15/25	00700X Use table X9	N1, 3, 4
	Two-hole spade for PCT	All	01000X Use table X9	N1
	One-hole spade for PCT	All	01100X Use table X9	N1
	PCT positioning bracket	All	PB-1	N1, 7

**N1.** Use with PCT1 or PCT2 terminators.

**N2.** Includes rod contact as standard. Specify suffix "-3" in place of "-4" for two-hole spade lug. Specify suffix "-5" in place of "-4" for one-hole spade lug.

**N3.** Use 1X for an aluminum rod contact for aluminum conductors only.

**N4.** Substitute 0X for 1X for a universal aluminum rod contact for aluminum or copper conductors.

**N5.** Use for insulation dia. range from 0.640" thru 1.070".

**N6.** Use for insulation dia. range from 0.830" thru 1.180".

**N7.** Fits overall cable O.D. from 0.750" to 1.625".

#### Terminations



PCT1



PCT2

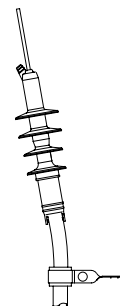

PB-1

# Cable terminations

Ordering instructions for modular terminators

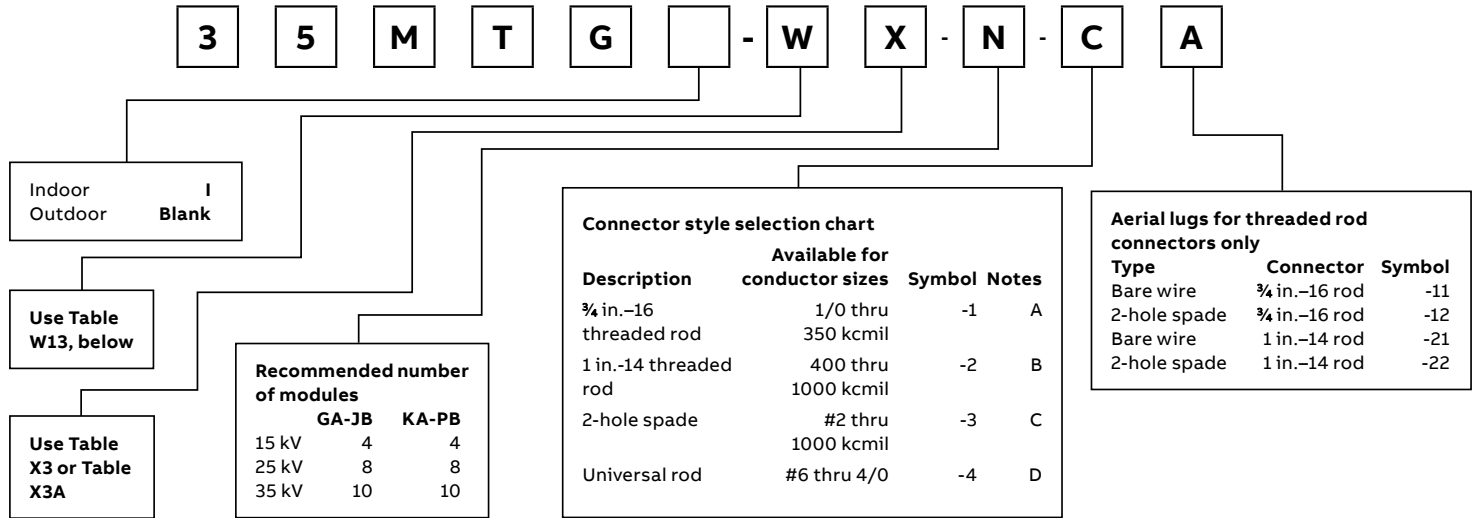

Note: Applicable table and available sizes depend upon connector style. Reference Connector Style Selection Chart and notes A through D.

- Notes
- A. Available for 1/0 through 350 conductor sizes only. Use Table X3 for size selection.
  - B. Available for 400 through 1000 conductor sizes only. Use Table X3A for size selection.
  - C. Available for #2 through 1000 conductor sizes only. Use Table X3 for size selection.
  - D. Available for #6 through 4/0 conductor sizes only. Use Table X3 for size selection.

Table W13

	Cable insulation diameter in (in.)		Symbol for W
	Min.	Max.	
Table W13 use for following products	0.775	0.885	GA
<b>35MTG</b>	0.825	0.935	GAB
<b>35MTGI</b>	0.875	0.985	GB
	0.930	1.040	GH
	0.980	1.115	HA
	1.040	1.175	HAB
	1.095	1.240	HB
	1.160	1.305	HJ
	1.220	1.375	JA
	1.285	1.395	JAB
	1.355	1.520	JB
	1.485	1.595	KA
	1.530	1.640	KAB
	1.575	1.685	KB
	1.665	1.785	PA
	1.755	1.875	PB

Table X3

	Conductor size AWG or kcmil	Symbol for X	
		Strand./compr.	Compt./Solid
Table X3 use for following products	#6	5	-
<b>35MTG</b>	#5	4	5
	#4	3	4
	#3	2	3
For use with style-1,-3, and -4 connectors only.	#2	1	2
	#1	0	1
	1/0	10	0
	2/0	20	10
	3/0	30	20
See notes A, C, and D for application information	4/0	40	30
	250	250	40
	300	300	250
	350	350	300
	400	400	350
	450	450	-
	500	500	400
	550	550	450
	600	600	500
	650	650	550
	700	750	600
	750	750	650
	800	800	750
	900	900	800
	1000	1000	900



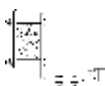
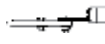



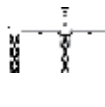



Table X3A

	Conductor size AWG or kcmil	Symbol for X	
		Strand./compr.	Compt./Solid
Table X3A use for following products	400	400	-
<b>35MTG</b>	450	450	400
	500	500	450
	550	550	500
	600	600	500
For use with style-2 connectors only.	650-700	650	550
	750	750	600
	800	750	650
	1000	1000	-
See notes B for application information			

## Cable terminations

### Terminations

#### Terminations

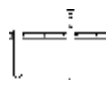
Illustration (not to scale)	Description	Voltage class	Cat. no.	Notes
	PCT positioning bracket	All	PB-1	N1, 12
	16THG bracket	All	16TB-2	N6
	Bracket for crossarm 16THG	All	16TB-3	N6
	Bracket for riser pole mounting 16THG	All	16TB-4	N6
	Bracket for tri-mounting 16THG	All	16TB-5	N6
	Kellums grip bracket	All	35MTB1-A	N1, 2, 6, 7
		All	35MTB1-B	N1, 3, 6, 7
		All	35MTB1-C	N1, 4, 6, 7
		All	35MTB1-D	N1, 5, 6, 7
	Kellums bracket for crossarm mounting	All	35MTB3-A	N1, 2, 6, 7
		All	35MTB3-B	N1, 3, 6, 7
		All	35MTB3-C	N1, 4, 6, 7
		All	35MTB3-D	N1, 5, 6, 7
	Bracket (for riser pole mounting)	All	35MTB4-A	N1, 2, 6, 7
		All	35MTB4-B	N1, 3, 6, 7
		All	35MTB4-C	N1, 4, 6, 7
		All	35MTB4-D	N1, 5, 6, 7
	Kellums bracket for tri-mounting	All	35MTB5-A	N1, 2, 6, 7
		All	35MTB5-B	N1, 3, 6, 7
		All	35MTB5-C	N1, 4, 6, 7
		All	35MTB5-D	N1, 5, 6, 7
	Aluma form bracket	All	1535AFB-1	N1, 6, 7, 13
	Aluma form bracket for crossarm mounting	All	1535AFB-3	N1, 6, 7, 13
	Aluma form bracket for riser-pole mounting	All	1535AFB-4	N1, 6, 7, 13
	Aluma form bracket for tri-mounting	All	1535AFB-5	N1, 6, 7, 13

**N1.** Use with PCT-1 or PCT-2 terminators.

**N2.** Fits overall cable O.D. from 1.195 in. to 1.625 in.

**N3.** Fits overall cable O.D. from 0.925 in. to 1.335 in.

**N4.** Fits overall cable O.D. from 0.890 in. to 1.185 in.

**N5.** Fits overall cable O.D. from 1.500 in. to 2.000 in.

**N6.** Use with 16THG and 16THGS terminators.

**N7.** Use with MTG, MTG1 and MSC terminators.

**N8.** For conductors from 1/0 thru 350 kcmil.

**N9.** For conductors from 400 kcmil thru 1000 kcmil.

**N10.** For conductors from #2 to 1000 kcmil.

**N11.** For conductors from #6 thru 4/0.

**N12.** Fits overall cable O.D. from 0.750 in. to 1.625 in.

**N13.** Fits overall cable O.D. from 0.750 in. to 2.000 in.

## Cable shield adapters and jacket seals

Elastimold elbows, cable joints and terminators have been designed for use on XLP, EPR or similar solid dielectric insulated power cables. These cables are available with a variety of optional shielding and jacket constructions. In order to properly mate and install the cable to an Elastimold product, the use of a shield adapter, grounding kit

or jacket seal may be required. The diagram below provides information concerning the application and selection of various shield adapters, grounding kits and jacket seals for the most popular cable types. Consult your ABB representative for recommendations concerning other cable constructions.

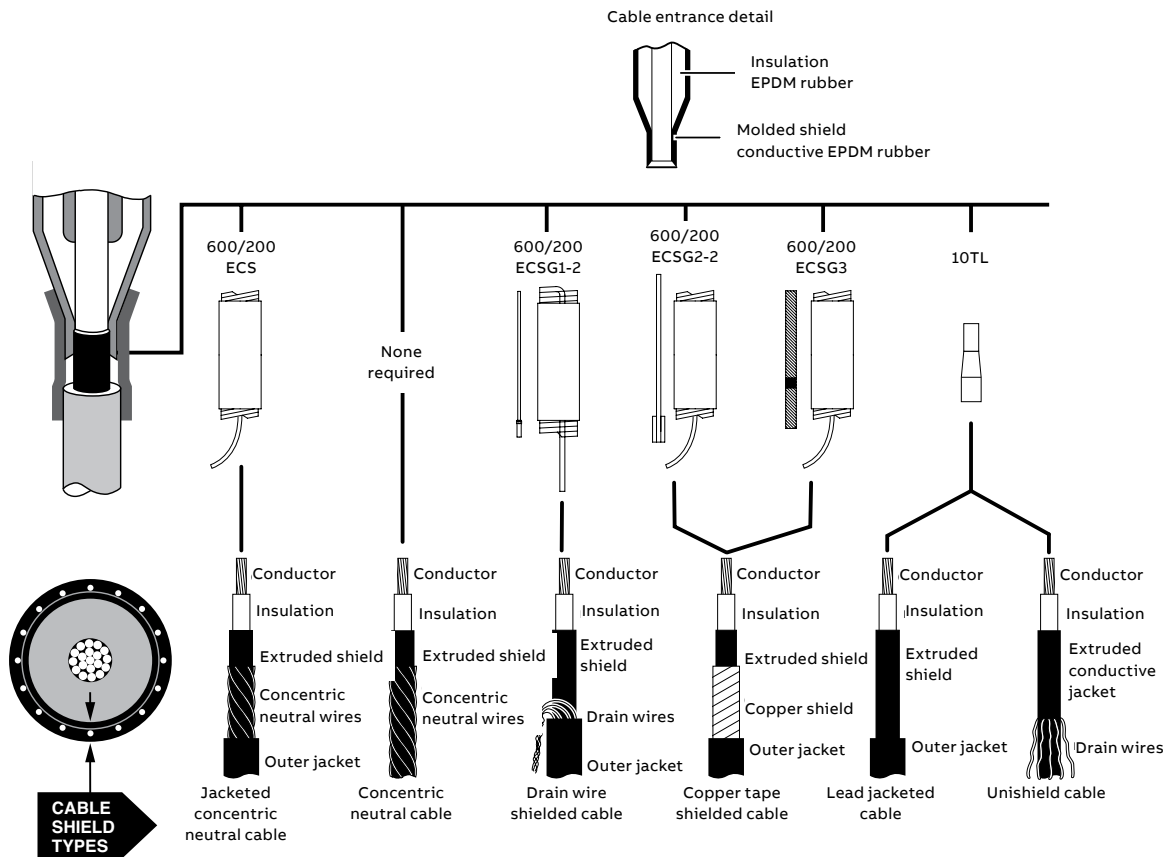

## Cable shield adapters and jacket seals



01 10TL

### Cable shield adapters

Cable Insulation dia.	10TL inches
Min.	0.495
Max.	1.875



02 ECS

### Jacket seals

Jacket O.D.	200ECS inches	600ECS inches
Min.	0.80	1.28
Max.	1.50	2.30

### Cable shield adapters and jacket seals

Image (not to scale)	Description	Cat. no.	Suffix	Notes
	Cold-shrinkable jacket seal	200ECS	-S	N1, 3
	Cold-shrinkable jacket seal	600ECS	-S	N1, 4
	Shield adapter	10TL-W	-TL	N1, 2
	Cold-shrinkable seal with copper rod and crimp connector	200ECSG1-2	-SG1	N1, 3, 5, 6
	Cold-shrinkable seal with copper rod and crimp connector	600ECSG1-2	-SG1	N1, 4, 5, 6
	Cold-shrinkable seal with copper rod and constant force spring	200ECSG2-2	-SG2	N1, 3, 5, 6
	Cold-shrinkable seal with copper rod and constant force spring	600ECSG2-2	-SG2	N1, 4, 5, 6
	Cold-shrinkable seal with copper braid and constant force spring	200ECSG3	-SG3	N1, 3, 5, 7
	Cold-shrinkable seal with copper braid and constant force spring	600ECSG3	-SG3	N1, 4, 5, 7

### 10TL insulation sizing

Insulation inches		
Min.	Max.	Symbol For W
0.495	0.585	EB
0.525	0.635	EF
0.575	0.585	FA
0.625	0.735	FAB
0.675	0.785	FB
0.725	0.835	FG
0.775	0.885	GA
0.825	0.935	GAB
0.875	0.985	GB
0.930	1.040	GH
0.980	1.115	HA
1.040	1.175	HAB
1.095	1.240	HB
1.160	1.305	HJ
1.220	1.375	JA
1.285	1.395	JAB
1.355	1.520	JB
1.485	1.595	KA
1.530	1.640	KAB
1.575	1.685	KB
1.755	1.875	PA

**N1.** To order the kits as separate items, use the catalog numbers shown in the table. Example: To order a cold-shrinkable tube as a separate item, use catalog number 200ECS.

To order the kits as components of other items, add the suffix to the end of the catalog number. Example: To order a cold-shrinkable jacket seal as a component of an elbow kit, use catalog number 162LR-A5200-S.

**N2.** Only use this suffix with catalog numbers that designate a "W" housing size. Sizing the main component will also size the suffix adapter.

**N3.** Size range 0.80" to 1.50" jacket diameters. Maximum installed diameter is approximately 2".

**N4.** Size range 1.28" to 2.30" jacket diameters. Maximum installed diameter is approx. 2.75".

**N5.** Voltage rating equal to Elastimold product being used.

**N6.** Copper rod size is No. 6 for sizes FA thru HA and No. 2 for sizes HAB thru JB.







**N7.** Braid is equivalent to No. 6 copper rod for sizes FA thru HA and No. 2 copper rod for sizes HAB thru JB.

## Equipment bushings

The ABB Elastimold brand offers a complete line of 200 A bushing well and 600 A series apparatus bushings for use on transformers, switchgear and other equipment applications. The bushings incorporate IEEE 386 standard interfaces (shown on page A6) and are constructed of molded epoxy with stainless steel flanges for mounting by

welding or gasketed clamp. Bushings are available for use on air, oil or SF6 insulated equipment. Units are rated for submersible, padmount, indoor, outdoor and other applications. Options include hold-down bail tabs and replaceable studs for 200-amp deepwell bushings.

### Equipment bushings

Image (not to scale)	Description	Voltage class (kV)	Cat. no.	Bushing shank length (in.)	Notes
	Short shank well with bail tabs and non-replaceable well stud	15/25	K1601PC-S1	2 <sup>3</sup> / <sub>4</sub>	N3, 7, 12
		35	L1601PC-S1		N3, 7, 12, 16
	Short shank well with bail tabs and replaceable well stud	15/25	K1601PC-S1-R	2 <sup>3</sup> / <sub>4</sub>	N1, 3, 7, 12
		35	L1601PC-S1-R		N1, 3, 7, 12, 16
	Short shank well without bail tabs and non-replaceable well stud	15/25	K1601PC-S2	2 <sup>3</sup> / <sub>4</sub>	N3, 7, 12, 15
		35	L1601PC-S2		N3, 7, 12, 15, 16
	Short shank well without bail tabs and with replaceable well stud	15/25	K1601PC-S2-R	2 <sup>3</sup> / <sub>4</sub>	N1, 3, 7, 12, 15
		35	L1601PC-S2-R		N1, 3, 7, 12, 15, 16
	Long shank well with bail tabs and non-replaceable well stud	15/25	K1601PC-T1	9 <sup>1</sup> / <sub>4</sub>	N3, 7, 12
		35	L1601PC-T1		N3, 7, 12, 16
	Long shank well with bail tabs and with replaceable well stud	15/25	K1601PC-T1-R	9 <sup>1</sup> / <sub>4</sub>	N1, 3, 7, 12
		35	L1601PC-T1-R		N1, 3, 7, 12, 16
	Long shank well without bail tabs and with non-replaceable well stud	15/25	K1601PC-T2	9 <sup>1</sup> / <sub>4</sub>	N3, 7, 12, 15
		35	L1601PC-T2		N3, 7, 12, 15, 16
	Long shank well without bail tabs and with replaceable well stud	15/25	K1601PC-T2-R	9 <sup>1</sup> / <sub>4</sub>	N1, 3, 7, 12, 15
		35	L1601PC-T2-R		N1, 3, 7, 12, 15, 16
	200 A deadbreak bushing	15/25	K180S4	2 <sup>9</sup> / <sub>16</sub>	N3, 7, 11
	200 A deadbreak bushing	15/25	K180T4	7 <sup>11</sup> / <sub>32</sub>	N3, 7, 11
	200 A deadbreak bushing	15/25	K180C4	9 <sup>1</sup> / <sub>4</sub>	N3, 7, 11
	600 A short shank bushing without stud	15/25	K650S1	2 <sup>15</sup> / <sub>16</sub>	N2, 5, 7, 12, 13, 15, 18, 19
	900 A Cu short shank bushing without stud	15/25	K675S1		N3, 5, 7, 12, 13, 15, 18 19
	600 A short shank bushing without stud	35	750S1		N2, 5, 7, 12, 14, 15, 16, 18 19
	600 A long shank bushing without stud	15/25	K650T1	8 <sup>9</sup> / <sub>16</sub>	N2, 5, 7, 12, 13, 15, 18
	900 A Cu long shank bushing without stud	15/25	K675T1	8 <sup>9</sup> / <sub>16</sub>	N3, 5, 7, 12, 13, 15, 18
	600 A long shank bushing without stud	35	750T1	8 <sup>9</sup> / <sub>16</sub>	N2, 5, 7, 12, 14, 15, 16, 18
	600 A 12" long shank bushing without stud	35	750L12	12	N2, 5, 7, 12, 14, 15, 16, 18
	600 A in-air long shank bushing without stud	15/25	K650TBC	8 <sup>9</sup> / <sub>16</sub>	N2, 4, 7, 6, 12
	900 A Cu in-air long shank bush without stud	15/25	K675TBC	-	N3, 5, 7, 6, 12
	Boot and collars for K600T1 to use in air	15/25	600BC	-	N6
	600 A bushing and gasket kit	15/25	600CK	-	-
		35	600CK	-	-
	200 A bushing clamp and gasket kit – 3 holes	15/25	K1601PC-S2-CK3H	-	17
		35	L1601PC-S2-CK3H	-	17
	200 A bushing clamp and gasket kit – 4 holes	15/25	K1601PC-S2-CK4H	-	17
		35	L1601PC-S2-CK4H	-	17

**N1.** Replacement stud available separately. Specify 1601RS.

**N2.** Equipped with standard aluminum conductor rod.

**N3.** Equipped with copper conductor rod.

**N4.** Includes 3/8-11 threaded stud at elbow end.

**N5.** Includes 3/8-11 threaded hole at elbow end.

**N6.** Provides increased creep and strike.

**N7.** Includes shipping cap.

**N11.** Parking stands for 200 A deadbreak applications are available as separate items. Specify 151PS.

**N12.** Parking stands for 200 A loadbreak and 600 A deadbreak applications are available as separate items. Specify 160PS.

**N13.** Aluminum stud available separately. Specify 650SA.

**N14.** Aluminum stud available separately. Specify 750SA.

**N15.** Available as a kit with clamp and gasket adding suffix "CK".

**N16.** Available for 35 kV with 200 kV BIL adding suffix "-200".

**N17.** For use on bushing well without bail tabs only.

**N18.** Add suffix "-CLB" for flange with stud clearance for clamping.

**N19.** Notched flange for bolted mounting add -NF

## Medium-voltage cable accessories technical information

### How to specify size-sensitive products

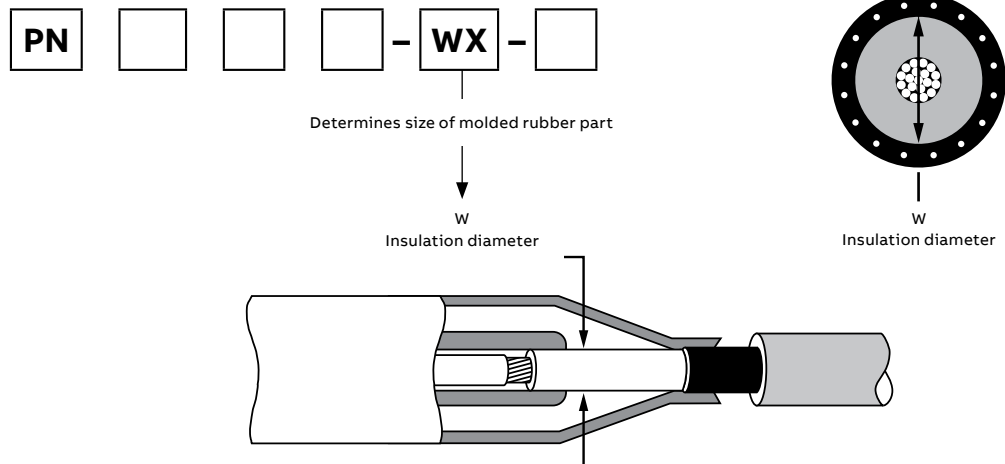

### Insulation diameter selection guide

Elastimold elbows, cable joints and terminations are designed for application on XLP, EPR and other solid-dielectric insulated power cables. These components are constructed of molded elastomer and rely on an interference fit with the cable insulation diameter in order to maintain proper dielectric strength, creep path integrity and a water seal. Elastimold components are available in a wide range of sizes in order to accommodate a variety of cable insulation diameters.

Selection of size-sensitive components requires determining the cable insulation diameter. This can be done in several ways:

- A. Refer to the cable manufacturer's spec sheet for dimensions.
- B. Measure the cable.
- C. If the cable conforms to AEIC or ICEA standards and is:
  1. 15 kV, 175-mil wall thickness, use the table on page A50.
  2. 15 kV, 220-mil wall thickness, use the table on page A51.

3. 25 kV, 260-mil wall thickness, use the table on page A52.
4. 35 kV, 345-mil wall thickness, use the table on page A52.

After the cable insulation diameter minimum and maximum have been determined:

1. Locate the W table indicated in the catalog number selection chart.
2. Complete the ordering information by selecting and inserting the symbol (given in the W table) into the catalog number.

---

## Medium-voltage cable accessories technical information

---

### Ordering examples

#### AEIC

To complete the information required to order a K655LR-W0X elbow for use on standard AEIC 1000 kcmil compressed stranding aluminum 25 kV cable with 0.260" thick insulation wall:

- A. Determine that the insulation diameter (for AEIC cable in the table on pages A50 to A52) is 1.645–1.770".
- B. For this elbow, the catalog number selection chart on page A19 indicates to use Table W7 for elbow sizing and Table X6 for connector sizing.
- C. From Table W7, the symbol for W is N.
- D. From Table X6, the symbol for X is 410.
- E. The completed catalog number, therefore, is K655LR-N0410.

#### ICEA

To complete the information required to order a K655LR-W0X elbow for use on standard ICEA 1000 kcmil compressed stranding aluminum 25 kV cable with 0.260" thick insulation wall:

- A. Determine that the insulation diameter (for ICEA cable in the table on pages A50 to A52) is 1.645 – 1.740".
- B. For this elbow, the catalog number selection chart on page A19 indicates to use Table W7 for elbow sizing and Table X6 for connector sizing.
- C. From Table W7, the symbol for W is N.
- D. From Table X6, the symbol for X is 410.
- E. The completed catalog number, therefore, is K655LR-N0410.



## Medium-voltage cable accessories technical information

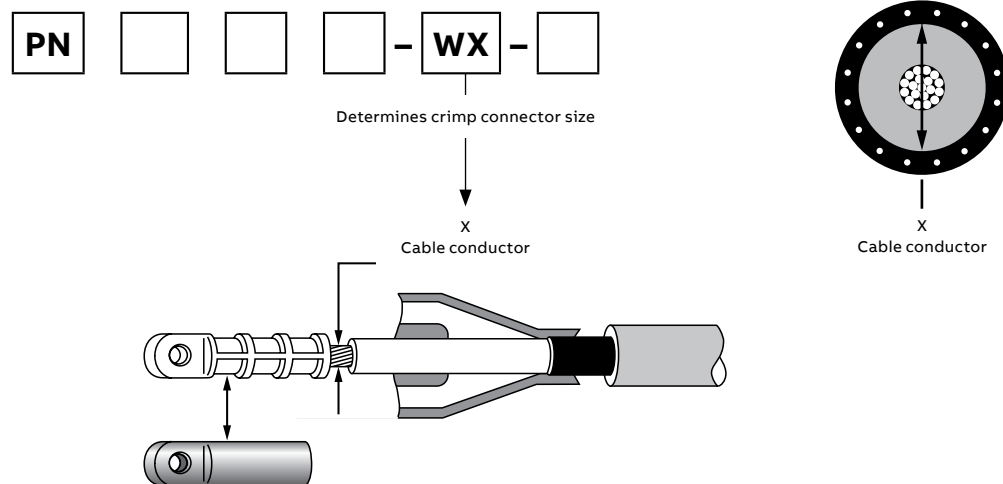

### Connector selection guide

Elastimold elbows, cable joints and terminations are furnished with crimp-style cable connectors. As standard, these connectors are constructed with a tin-plated aluminum barrel filled with an oxide inhibitor. Most aluminum barrel connectors are universal and are designed for use on either aluminum or copper conductor cable.

When specified, all copper crimp-style connectors can be furnished. These connectors are only for use on copper conductor cable and are not for use with aluminum conductor cables. Bi-metallic connectors are constructed with a copper top and an aluminum barrel. Bi-metal connectors can be used on either aluminum or copper conductor cable and are furnished as standard with 200 A loadbreak elbows and 200 A deadbreak elbows. PCT and R2T terminators are furnished with rod connectors.

#### Aluminum connectors used in PCJ cable joints are rated as follows:

- Aluminum conductor to aluminum conductor, cable rated
- Aluminum conductor to copper conductor, cable rated equal to the aluminum cable

#### Copper connectors used in PCJ cable joints are rated as follows:

- Copper conductor to copper conductor, cable rated

Selecting and ordering the proper crimp connector requires determining information relative to the cable conductor as follows:

- Conductor size in AWG or kcmil
- Conductor type (stranded, compressed, compact or solid)
- Conductor material (aluminum or copper)

After the cable conductor information has been determined:

1. Locate the X table indicated in the catalog number selection chart.
2. Complete the ordering information by selecting and inserting the symbol (given in the X table) into the catalog number.

See the ordering examples on page A48 for further information.

## Medium-voltage cable accessories technical information

### AEIC and ICEA cable insulation diameter

**AEIC CS8-06**

Specification for extruded dielectric, shielded power cable rated 5–46 kV

AEIC-calculated diameters – Solid and compressed stranding from tables C-4 and C-6 and compact stranding from tables C-5 and C-7

**ANSI/ICEA S-94-649-2004 & S-97-682-2000**

Standard for concentric neutral cables and utility shielded power cables rated 5–46 kV

ICEA – Concentric stranding from table C-3, compressed stranding from table C-4, compact stranding from table C-5

ICEA abbreviated – For additional cables, please refer to the standard

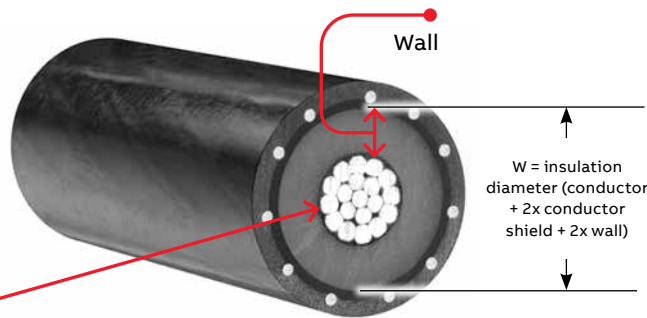

- 15 kV 100% – 175 mil insulation (0.175")
- 15 kV 133% – 220 mil insulation (0.220")
- 25 kV 100% – 260 mil insulation (0.260")
- 35 kV 100% – 345 mil insulation (0.345")

15 kV cable (100% level, 175 mil)

Aluminum and copper conductor size (AWG or kcmil)	Industry standard	Solid conductor		Stranded conductor		Compressed conductor		Compact conductor	
		Diameter in inches over insulation		Diameter in inches over insulation		Diameter in inches over insulation		Diameter in inches over insulation	
		Min.	Max.	Min.	Max.	Min.	Max.	Min.	Max.
#2	AEIC	0.610	0.700	–	–	0.635	0.725	0.620	0.710
	ICEA	0.610	0.695	0.645	0.730	0.635	0.720	0.620	0.705
#1	AEIC	0.645	0.730	–	–	0.675	0.765	0.655	0.740
	ICEA	0.645	0.725	0.685	0.770	0.675	0.760	0.655	0.735
1/0	AEIC	0.680	0.770	–	–	0.715	0.805	0.690	0.775
	ICEA	0.680	0.760	0.725	0.810	0.715	0.800	0.690	0.775
2/0	AEIC	–	–	–	–	0.760	0.850	0.730	0.815
	ICEA	–	–	0.775	0.855	0.760	0.845	0.730	0.815
3/0	AEIC	–	–	–	–	0.810	0.900	0.775	0.865
	ICEA	–	–	0.825	0.905	0.810	0.895	0.775	0.860
4/0	AEIC	–	–	–	–	0.865	0.955	0.830	0.915
	ICEA	–	–	0.880	0.965	0.865	0.950	0.830	0.910
250	AEIC	–	–	–	–	–	–	–	–
	ICEA	–	–	0.935	1.020	0.920	1.005	0.880	0.965
350	AEIC	–	–	–	–	1.025	1.115	0.980	1.065
	ICEA	–	–	1.045	1.130	1.025	1.110	0.980	1.065
500	AEIC	–	–	–	–	1.150	1.245	1.100	1.185
	ICEA	–	–	1.175	1.260	1.150	1.235	1.100	1.185
750	AEIC	–	–	–	–	1.340	1.440	1.280	1.370
	ICEA	–	–	1.370	1.455	1.340	1.425	1.280	1.365
1000	AEIC	–	–	–	–	1.485	1.590	1.430	1.520
	ICEA	–	–	1.520	1.610	1.485	1.575	1.430	1.515

ICEA Note: Diameters specified in the above table are different than specified by AEIC CS8-00. Consult accessory manufacturer for proper selection of accessories. Diameters to be measured in accordance with 9.6.

## Medium-voltage cable accessories technical information

### AEIC and ICEA cable insulation diameter

15 kV cable (133% level, 220 mil)

Aluminum and copper conductor size (AWG or kcmil)	Industry standard	Solid conductor		Stranded conductor		Compressed conductor		Compact conductor	
		Diameter in inches over insulation		Diameter in inches over insulation		Diameter in inches over insulation		Diameter in inches over insulation	
		Min.	Max.	Min.	Max.	Min.	Max.	Min.	Max.
#2	AEIC	0.700	0.790	-	-	0.725	0.815	0.710	0.800
	ICEA	0.700	0.790	0.735	0.825	0.725	0.815	0.710	0.800
#1	AEIC	0.735	0.820	-	-	0.765	0.855	0.745	0.830
	ICEA	0.735	0.820	0.775	0.865	0.765	0.855	0.745	0.830
1/0	AEIC	0.770	0.860	-	-	0.805	0.895	0.780	0.865
	ICEA	0.770	0.855	0.815	0.905	0.805	0.895	0.780	0.865
2/0	AEIC	-	-	-	-	0.850	0.940	0.820	0.905
	ICEA	-	-	0.865	0.950	0.850	0.935	0.820	0.905
3/0	AEIC	-	-	-	-	0.900	0.990	0.865	0.955
	ICEA	-	-	0.915	1.000	0.900	0.985	0.865	0.955
4/0	AEIC	-	-	-	-	0.955	1.045	0.920	1.005
	ICEA	-	-	0.970	1.060	0.955	1.045	0.920	1.005
250	AEIC	-	-	-	-	-	-	-	-
	ICEA	-	-	1.025	1.115	1.010	1.100	0.970	1.060
350	AEIC	-	-	-	-	1.115	1.205	1.070	1.155
	ICEA	-	-	1.135	1.220	1.115	1.200	1.070	1.155
500	AEIC	-	-	-	-	1.240	1.335	1.190	1.275
	ICEA	-	-	1.265	1.355	1.240	1.330	1.190	1.275
750	AEIC	-	-	-	-	1.430	1.530	1.370	1.460
	ICEA	-	-	1.460	1.550	1.430	1.520	1.370	1.460
1000	AEIC	-	-	-	-	1.575	1.680	1.520	1.610
	ICEA	-	-	1.610	1.705	1.575	1.670	1.520	1.610

## Medium-voltage cable accessories technical information

### AEIC and ICEA cable insulation diameter

#### 25 kV cable (100% Level, 260 mil)

Aluminum and copper conductor size (AWG or kcmil)	Industry standard	Solid conductor		Stranded conductor		Compressed conductor		Compact conductor	
		Diameter in inches over insulation		Diameter in inches over insulation		Diameter in inches over insulation		Diameter in inches over insulation	
		Min.	Max.	Min.	Max.	Min.	Max.	Min.	Max.
#1	AEIC	0.805	0.900	–	–	0.835	0.935	0.815	0.910
	ICEA	0.805	0.895	0.845	0.935	0.835	0.925	0.815	0.905
1/0	AEIC	0.840	0.940	–	–	0.875	0.975	0.850	0.945
	ICEA	0.840	0.930	0.885	0.980	0.875	0.965	0.850	0.940
2/0	AEIC	–	–	–	–	0.920	1.020	0.890	0.985
	ICEA	–	–	0.935	1.025	0.920	1.010	0.890	0.980
3/0	AEIC	–	–	–	–	0.970	1.070	0.935	1.035
	ICEA	–	–	0.985	1.075	0.970	1.060	0.935	1.030
4/0	AEIC	–	–	–	–	1.025	1.125	0.990	1.085
	ICEA	–	–	1.040	1.135	1.025	1.115	0.990	1.080
250	AEIC	–	–	–	–	–	–	–	–
	ICEA	–	–	1.095	1.190	1.080	1.175	1.040	1.135
350	AEIC	–	–	–	–	1.185	1.295	1.140	1.245
	ICEA	–	–	1.205	1.295	1.185	1.275	1.140	1.230
500	AEIC	–	–	–	–	1.310	1.425	1.260	1.365
	ICEA	–	–	1.335	1.430	1.310	1.405	1.260	1.350
750	AEIC	–	–	–	–	1.500	1.620	1.440	1.550
	ICEA	–	–	1.530	1.625	1.500	1.595	1.440	1.535
1000	AEIC	–	–	–	–	1.645	1.770	1.590	1.700
	ICEA	–	–	1.680	1.775	1.645	1.740	1.590	1.685

#### 35 kV cable (100% level, 345 mil)

Aluminum and copper conductor size (AWG or kcmil)	Industry standard	Solid conductor		Stranded conductor		Compressed conductor		Compact conductor	
		Diameter in inches over insulation		Diameter in inches over insulation		Diameter in inches over insulation		Diameter in inches over insulation	
		Min.	Max.	Min.	Max.	Min.	Max.	Min.	Max.
1/0	AEIC	1.010	1.110	–	–	1.045	1.145	1.020	1.115
	ICEA	1.010	1.110	1.055	1.155	1.045	1.145	1.020	1.120
2/0	AEIC	–	–	–	–	1.090	1.190	1.060	1.155
	ICEA	–	–	1.105	1.200	1.090	1.190	1.060	1.160
3/0	AEIC	–	–	–	–	1.140	1.240	1.105	1.205
	ICEA	–	–	1.155	1.255	1.140	1.240	1.105	1.205
4/0	AEIC	–	–	–	–	1.195	1.295	1.160	1.255
	ICEA	–	–	1.210	1.310	1.195	1.295	1.160	1.260
250	AEIC	–	–	–	–	–	–	–	–
	ICEA	–	–	1.265	1.370	1.250	1.350	1.210	1.315
350	AEIC	–	–	–	–	1.355	1.470	1.310	1.420
	ICEA	–	–	1.375	1.475	1.355	1.455	1.310	1.410
500	AEIC	–	–	–	–	1.480	1.600	1.430	1.540
	ICEA	–	–	1.505	1.605	1.480	1.580	1.430	1.530
750	AEIC	–	–	–	–	1.670	1.795	1.610	1.725
	ICEA	–	–	1.700	1.800	1.670	1.770	1.610	1.710
1000	AEIC	–	–	–	–	1.815	1.945	1.760	1.875
	ICEA	–	–	1.850	1.955	1.815	1.920	1.760	1.865

ICEA Note: Diameters specified in the above table are different than specified by AEIC CS8-00. Consult accessory manufacturer for proper selection of accessories. Diameters to be measured in accordance with 9.6.

## Conductor diameters for copper and aluminum (Class B) stranded, compressed, compact and solid cables

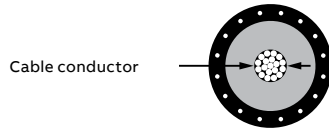

Conductor diameters for copper and aluminum (Class B) stranded, compressed, compact and solid cables

Conductor size (AWG or kcmil)	No. of strands and their nom. strand dia. (in.)	Cross-sectional area		Stranded conductors (inches)	Compressed conductors (inches)	Compact conductors (inches)	Solid conductors (inches)
		Square inches	mm <sup>2</sup> conversion				
#14	7 x 0.0242	0.0032	2.08	0.073	-	-	0.064
#12	7 x 0.0305	0.0051	3.31	0.092	-	-	0.081
#10	7 x 0.0385	0.0082	5.26	0.116	-	-	0.102
#8	7 x 0.0486	0.0130	8.37	0.146	-	-	0.129
#6	7 x 0.0612	0.0206	13.30	0.184	-	-	0.162
#4	7 x 0.0772	0.0328	21.15	0.232	-	-	0.204
#2	7 x 0.0974	0.0521	33.62	0.292	0.283	0.268	0.258
#1	19 x 0.0664	0.0657	42.41	0.332	0.322	0.299	0.289
1/0	19 x 0.0745	0.0829	53.49	0.373	0.362	0.336	0.325
2/0	19 x 0.0837	0.1054	67.43	0.418	0.405	0.376	-
3/0	19 x 0.0940	0.1318	85.01	0.470	0.456	0.423	-
4/0	19 x 0.1055	0.1662	107.2	0.528	0.512	0.475	-
250	37 x 0.0822	0.1964	127	0.575	0.558	0.520	-
350	37 x 0.0973	0.2749	177	0.681	0.661	0.616	-
500	37 x 0.1162	0.3924	253	0.813	0.789	0.736	-
600	61 x 0.0992	0.4712	304	0.893	0.866	0.813	-
700	61 x 0.1071	0.5498	355	0.964	0.935	0.877	-
750	61 x 0.1109	0.5890	380	0.998	0.968	0.908	-
800	61 x 0.1145	0.6283	405	1.031	1.000	0.938	-
900	61 x 0.1215	0.7069	456	1.094	1.061	0.999	-
1000	61 x 0.1280	0.7854	507	1.152	1.117	1.060	-
1100	91 x 0.1099	0.8639	557	1.209	1.173	-	-
1200	91 x 0.1148	0.9425	608	1.263	1.225	-	-
1250	91 x 0.1172	0.9818	633	1.289	1.250	-	-
1300	91 x 0.1195	1.021	659	1.315	1.276	-	-
1400	91 x 0.1240	1.100	709	1.364	1.323	-	-
1500	91 x 0.1284	1.178	760	1.412	1.370	-	-
1600	127 x 0.1122	1.257	811	1.459	1.415	-	-
1700	127 x 0.1157	1.335	861	1.504	1.459	-	-
1750	127 x 0.1174	1.374	887	1.526	1.480	-	-
1800	127 x 0.1191	1.414	912	1.548	1.502	-	-
1900	127 x 0.1223	1.492	963	1.590	1.542	-	-
2000	127 x 0.1225	1.571	1010	1.632	1.583	-	-

## Medium-voltage cable accessories technical information

Table W

Table W

Applicable cat. no. use for following products	Cable insulation diameter in inches		Symbol for W	Applicable cat. no. use for following products	Cable insulation diameter in inches		Symbol for W
	Min.	Max.			Min.	Max.	
<b>Table W1</b>				<b>Table W7</b>			
151SP/SR	0.575	0.740	A	K656I/CY/CH	0.420	0.660	D
151LS/LY	0.635	0.905	B	K655/656LR	0.530	0.680	E
161DLR				K655/656SR			
161/162LR	0.805	1.060	C	655/656LINK	0.640	0.820	F
161/162LRJS	0.890	1.220	D	K655/656LINK	0.760	0.950	G
161LR/161LRJS	1.090	1.310	E	655/656ETP	0.850	1.050	H
261LR/261LRJS				K655/656ETP	0.980	1.180	J
162LR/162LRJS				655/656RTP	1.090	1.310	K
261DLR				K655/656LRTP	1.180	1.465	L
262LR/262LRJS				655/656BI-LINK	1.280	1.430	LM
					1.370	1.630	M
					1.550	1.780	N
					1.665	1.785	PA
					1.725	1.935	P
<b>Table W2</b>				<b>Table W8</b>			
273RLR	0.760	0.950	G	15PCJ-1	0.640	0.820	F
274RLR	0.850	1.050	H	15PCJ-2	0.760	0.950	G
273DLR	0.980	1.180	J		0.850	1.050	H
	1.090	1.310	K		0.980	1.180	J
					1.090	1.310	K
					1.180	1.465	L
					1.280	1.430	LM
					1.370	1.630	M
					1.515	1.780	N
					1.725	1.935	P
					1.900	2.120	Q
<b>Table W3</b>				<b>Table W9</b>			
375LR	0.850	1.050	H	25PCJ-1	0.760	0.950	G
376LR	0.980	1.180	J	25PCJ-2	0.850	1.050	H
	1.090	1.310	K	755/756LR	0.980	1.180	J
	1.235	1.465	L	755/756LINK	1.090	1.310	K
				755/756ETP	1.090	1.310	K
				755/756LRTP	1.180	1.465	L
				755/756BI-LINK	1.370	1.630	M
				755CA/CK/TCK	1.515	1.780	N
					1.725	1.935	P
					1.900	2.120	Q
					2.115	2.235	R
<b>Table W4</b>							
167/168RLR	0.640	0.820	F				
167LRT	0.760	0.950	G				
	0.850	1.050	H				
	0.980	1.180	J				
	1.090	1.310	K				
<b>Table W5</b>							
167/168ELR	0.665	0.895	6689				
273/274DELRL	0.740	0.950	7495				
273/274ELR	0.880	1.100	88110				
167/168DELRL	1.090	1.310	K				
<b>Table W6</b>							
10EP	0.495	0.585	EB				
152EA	0.525	0.635	EF				
160CA*	0.575	0.685	FA				
(*EB-FA only)	0.625	0.735	FAB				
	0.675	0.785	FB				
	0.725	0.835	FG				
	0.775	0.885	GA				
	0.825	0.935	GAB				
	0.875	0.985	GB				

## Medium-voltage cable accessories technical information

### Table W & Table X

Table W (continued)

Applicable cat. no. use for following products	Conductor size AWG or kcmil	Symbol for W		Applicable cat. no. use for following products	Conductor size AWG or kcmil	Symbol for W	
		Strand./ compr.	Compt./ solid.			Strand./ compr.	Compt./ solid.
<b>Table W10</b>				<b>Table W16</b>			
35PCJ-1	0.850	1.050	H	252LR	0.575	0.740	A
35PCJ-2	0.980	1.180	J	252LRJS	0.635	0.905	B
	1.090	1.310	K		0.805	1.060	C
	1.180	1.465	L		0.890	1.220	D
	1.370	1.630	M		1.090	1.310	E
	1.515	1.780	N				
	1.725	1.935	P				
	1.900	2.120	Q				

Table X

Applicable cat. no. use for following products	Conductor size AWG or kcmil	Symbol for X		Applicable cat. no. use for following products	Conductor size AWG or kcmil	Symbol for X	
		Strand./ compr.	Compt./ solid.			Strand./ compr.	Compt./ solid.
<b>Table X1</b>				<b>Table X6</b>			
167/168ELR/DELRL	#2	210	220	K655/656ETP	650	750/800	360
273/274ELR/DELRL	#1	220	230	755/756ETP	700/750	900	380
156LR, 161/162LR	1/0	230	240	655/656BI-LINK	800	-	390
261/262LR,167LRT	2/0	240	250	K655/656BI-LINK	900	1,000	400
167/168RLR,167DLR	3/0	250	260	755BI-LINK	1,000	-	410
273/274RLR,273DLR	4/0	260	270	655CK, 755CK	-	1,250	420
00400, 02500, 02509, 02702,	250	270	-	655TCK, 03600	-	-	440
02800, K151SP/SR,				03602, 03700, 03702	1250	-	440
375LR/376LR							
<b>Table X2</b>				<b>Table X7</b>			
375/376LR	1/0	230	240	15PCJ1	#2	220	210
375/376LR	2/0	240	250	25PCJ1	#1	230	220
	3/0	250	260	35PCJ1	1/0	240	230
	4/0	260	270	15PCJ2	2/0	250	240
				25PCJ2	3/0	260	250
				35PCJ2	4/0	270	260
					250	280	270
					350	300	290
					500	330	310
					750	380	360
					1,000	410	400
					1,250	440	420
<b>Table X6</b>				<b>Table X9</b>			
655/656LRTP	-	#2	210	PCT1	#2	220	210
K655/656LRTP	#2	#1	220	PCT2	#1	230	220
755/756LRTP	#1	1/0	230	01000	1/0	240	230
K656I/Y/H, K655/656LR	1/0	2/0	240	01010	2/0	250	240
755/756LR, K655/656SR	2/0	3/0	250		3/0	260	250
655/656LINK, K655/656LINK	3/0	4/0	260		4/0	270	260
755/756LINK, 655/656ETP	4/0	250	270				
K655/656ETP, 755/756ETP	250	300	280				
655/656BI-LINK	300	350	290				
K655/656BI-LINK	350	400	300				
755BI-LINK, 655CK	400	450	310				
755CK, 655TCK, 03600,	450	500/550	320				
03602, 03700, 03702	500	600	330				
K655/656LRTP	550	650	340				
755/756LRTP, K656I/Y/H	600	700	350				
K655/656LR, K655/656LR							
755/756LR, K655/656SR							
655/656LINK, K655/656LINK							
755/756LINK, 655/656ETP							
K655/656ETP, 755/756ETP							

## Shrink-Fit cable joints

—  
01 SFJ225 Shrink-Fit cable joint

—  
02 Disposable four-piece plastic support core

—  
03 SFJ with -RK restoration kit option

### Splice medium-voltage cables fast – No ripcords, no heat!

For over 50 years, the Elastimold brand has been associated with reliable, high-quality, pre-molded power cable splices that are designed to stand the rigors of the toughest utility applications. These products provide a cost-effective method to splice medium voltage cables using a push-on motion, and allowing cable neutrals to be solidly connected across the body of the splice without the use of any external braids. For those who prefer a more range-taking solution without the use of any physical force to install, the only options available have been cumbersome heat-shrink products that require multiple steps and the use of an open flame that makes achieving uniform cable coverage tedious and time-consuming or braid/jacket combinations that make achieving a solid neutral connection across the splice a challenge.

Now there's a faster and easier way to splice medium-voltage cables – One that combines all of the convenience and flexibility of a pre-molded splice, with the range-taking ease of installation offered in a cold- or heat-shrink product, but without the use of ripcords, heat or excessive force. Introducing the Elastimold Shrink-Fit cable joints from ABB.

The Shrink-Fit cable joints are made of the same molded EPDM elastomer as our other Elastimold cable accessories. This high-performance material offers more durability than silicone for direct burial. The joints feature a four-piece plastic support core, which is placed over the cable for installation of the splice. The support core is then easily removed with the supplied tool, allowing the elastomer joint to contour over the spliced cable for a uniform seal every time.



—  
01

Each Elastimold Shrink-Fit cable joint covers a wide range of cable sizes, features an insulated, semi-conductive shield and can be used with either a standard aluminum or optional copper compression splice. Optional kits are available for neutral, shielding and jacket restoration.

#### Features

- Core removal without ripcords or heat required for installation
- High-quality molded EPDM elastomer housing withstands the elements in harsh direct-burial, vault, manhole and overhead applications
- Four sizes support a wide range of cable and conductor sizes
- IEEE 404 rated Shrink-Fit cable joint
- Includes restoration kit

#### Typical applications

- Direct burial
- Handhole/pullbox
- Manhole
- Vault
- Overhead



—  
02



—  
03



## Shrink-Fit cable joints

— 01 Place Elastimold Shrink-Fit joint in position.

— 02 Install connector.

— 03 Cut fastening straps.

— 04 Core detachment begins. An optional tool may be used to aid core ejection.

— 05 Core pushes itself toward the ends of the Shrink-Fit joint.

— 06 Core ejects from second end.

— 07 Last core piece detaches.

— 08 Crimp grounding wires for kits with an -RK restoration kit option, using the integrated copper braid and jacket seal to complete the connection.

### Installation sequence



01



02



03



04



05



06



07

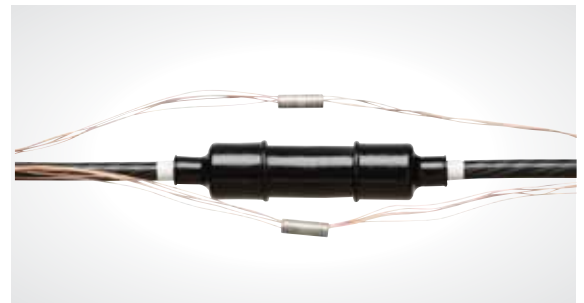

08

**Warning:** Refer to local code for required PPE.

## Shrink-Fit cable joints

### Ratings

Voltage class (kV)	15	25/28	35
Max. phase-to-ground operating voltage (kV)	8.7	14.4	20.2
BIL impulse withstand (1.2 x 50µsec. wave) (kV)	110	150	200
Corona extinction level @ 3.0 pC sensitivity (kV)	13	22	30
DC withstand during installation (kV)	56	80	100
DC withstand up to 5 yrs.* – XLPE insulation (kV)	18	25	31
DC withstand up to 5 yrs.* – EPR insulation (kV)	45	64	80
AC withstand at 60 Hz for 60 sec. (kV)	35	52	69
Continuous current	Equal to that of cable	Equal to that of cable	Equal to that of cable
Short-term current	Equal to that of cable up to 35 kA	Equal to that of cable up to 35 kA	Equal to that of cable up to 35 kA

\*Reference: AEC CS6 and CS8, section L.2.

### Dimensions

Cable joint size	D (in.)	L (in.)
1	1.85	11
2	2.12	16
3	2.40	18
4	2.60	18

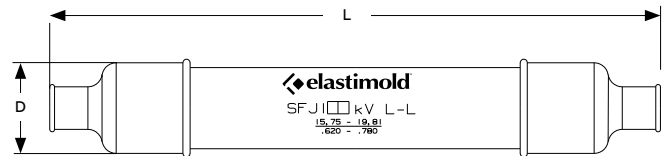

### Insulation range

Cable joint size	Min. (in.)	Max. (in.)	Min. (mm)	Max. (mm)
1	0.610	0.860	15.49	21.84
2	0.805	1.060	20.44	26.92
3	0.935	1.355	23.75	34.41
4	1.210	1.920	30.73	48.76

## Shrink-Fit cable joints

The following diagram shows how to construct a catalog number for an Elastimold Shrink-Fit cable joint:

Indicates field that must be filled in to complete the catalog number.

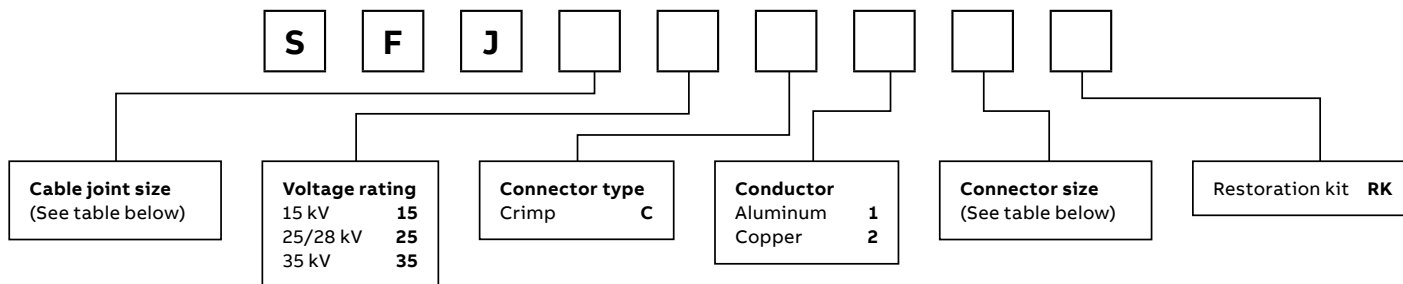

### Cable joint size

Size code	Wall thickness (mils)	Compact (AWG or kcmil)		Compressed (AWG or kcmil)	
		Min. conductor size*	Max. conductor size*	Min. conductor size*	Max. conductor size*
<b>15 kV</b>					
1	175	#2	3/0	#2	2/0
2	175	4/0	250	3/0	4/0
3	175	350	600	250	500
4	175	700	1000	600	1000
1	220	#2	1/0	#2	#1
2	220	2/0	4/0	1/0	3/0
3	220	250	500	4/0	350
4	220	600	1000	500	1000
<b>25/28 kV</b>					
2	260	#1	3/0	#2	1/0
3	260	3/0	350	2/0	250
4	260	500	1000	350	1000
<b>35 kV</b>					
3	345	1/0	4/0	#1	3/0
4	345	250	1000	4/0	1000

### Connector size

X code	Conductor size (AWG or kcmil)	
	Stranded/compressed	Solid/compact
210	-	#2
220	#2	#1
230	#1	1/0
240	1/0	2/0
250	2/0	3/0
260	3/0	4/0
270	4/0	250
280	250	300
290	300	350
300	350	400
310	400	500
330	500	600
360	650	750
380	750	900
400	900	1000
410	1000	-

\* Based on the minimum compact AEIC and ICEA cable insulation diameters.  
 Note: Each kit contains Shrink-Fit housing on removable core, splice connector, lubricant, installation instructions and crimp chart. For ordering information on optional neutral, shielding and jacket restoration kits, please contact ABB Customer Service.

## Distribution shrink-fit terminations

### Ranger2™ terminations

- Silicone polymer housing provides superior memory and weathering characteristics
- Shrink-fit housing uses common installation procedures and cable preparation dimensions, and field-removable center core allows for easy installation
- Three different shed designs for superior weathering:
  - Four sheds for 15 kV outdoor model
  - Six sheds for 25/28 kV outdoor model
  - Eight sheds for 35 kV outdoor model
- Three sizes cover entire cable range from #2 AWG to 1250 kcmil
- Units accommodate popular XLP and EPR cable types and various shield constructions
- Integral Hi-K voltage stress-control tube provides uniform voltage grading over the length of the termination and eliminates damaging voltage stress concentrations at the cable insulation shield edge
- Thick wall construction securely maintains critical interface pressure for consistent long-term reliability and performance
- Pull-down tabs for easy installation of built-in jacket seal – Accommodate CN, JCN, tape, wire or LC shielded cable construction
- Lightweight, compact design installs in restricted spaces and permits application where free hanging is desired
- Dark gray molded silicone insulator uses specially formulated silicone materials with improved UV stability, track, erosion and weather resistance for enhanced performance under the worst environmental conditions
- Optional connectors with copper stem and one-hole or two-hole spade
- Optional cable and support bracket with three sizes ranging from 0.80"–2.40" O.D.

### Silicone polymer housings

The R2T and R2IT terminations are manufactured using an optimized weather-resistant silicone formulation. The housing offers superior cable sealing and voltage withstand characteristics.

Elastimold terminations meet or exceed all requirements of IEEE 48 for Class 1 outdoor or Class 2 indoor terminations. Unit tests include voltage withstand wet and dry, before and after load cycling on units installed on maximum conductor sized cable.

#### Kit contents

Every R2T and R2IT comes complete with housing and stress tube preassembled on the core, ready for installation. Easy-to-read installation instructions will take you from cable preparation through installation. All kits include a tube of silicone grease, two plastic gloves and two strips of self-fusing silicone tape. Outdoor kits also include mastic for sealing. Metallic tape (M) kits include a grounding adapter for tape shield, wire shield and unshield cables. LC shield (L) kits include a high ampacity grounding adapter for longitudinally corrugated shield, tape shield and wire over tape shield cables.



## Distribution shrink-fit terminations

### Ranger2 terminations

#### Stress relief

The R2T and R2IT terminations provide electric stress control for the cable by means of a flexible tube with a high permittivity dielectric constant.

The stress-relief tube is preassembled on the core under the polymer housing. As the core is removed, the stress-relief tube and housing shrink onto the cable at the same time, in exactly the right position. No secondary operations are required during installation. The electrical fields are refracted through the high dielectric constant tube and housing as shown.

#### Installation

Standard cable preparation techniques are used for all R2T Elastimold Ranger2 outdoor terminations and R2IT Elastimold Ranger2 indoor terminations. The Elastimold shrink-fit terminations are assembled on a removable core. After the termination is placed onto the prepared cable, the core is removed by pulling on the end. The housing then collapses onto the prepared cable. Memory of the material provides the interface solid dielectric and sealing properties required to meet the electrical ratings and prevent the ingress of moisture.

#### Certified

Elastimold Ranger2 terminations have been designed and tested per applicable portions of ANSI, IEEE, AEIC, ICEA and other industry standards.

##### IEEE 48

Standard for indoor and outdoor cable terminations.

##### ANSI C119.4

Standard for cable connectors for aluminum and copper conductors.

##### AEIC CS8-06 and ANSI/ICEA S-94-649-2004 and S-97-682-2000

Standards for XLP and EPR insulated cables.

#### Voltage stress

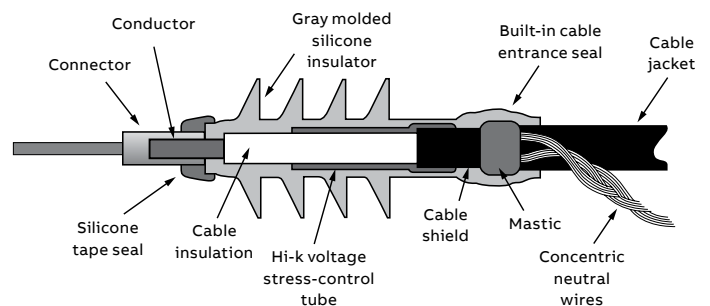
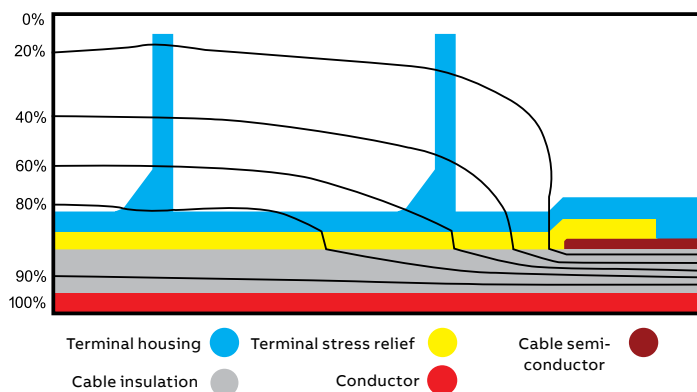

## Distribution shrink-fit terminations

### Ranger2 terminations

#### Ratings

	R2IT15 indoor	R2T15 outdoor	R2T28 outdoor	R2T35 outdoor
Sizes available*	1, 2, 4	1, 2, 4	2, 4	2, 4
Voltage rating (kV)	15	15	25/28	35
Max. design voltage to ground (kV)	9.5	9.5	16	22
Corona extinction voltage (kV) ( $\leq 3$ pC) (partial discharge)	13	13	22	30
<b>Insulation withstand voltage:</b>				
Lightning impulse (BIL dry 110 withstand) (kV crest)	110	110	150	200
10 Sec. wet (60 Hz) (kV)	–	45	60	80
1 Minute dry (60 Hz) (kV)	50	50	65	90
5 Hour dry (60 Hz) (kV)	35	35	55	75
DC withstand 15 min. dry (kV)	75	75	105	140

#### Application information

IEEE 48 classification	Outdoor = Class 1A, indoor = Class 2
Ambient temperature range	-30 °C to 65 °C
Power system frequency	48 to 62 Hz
Altitude range	3,300 feet max.
Mounting	Free hanging or optional bracket

#### Dimensions

	R2IT15 indoor	R2T15 outdoor	R2T28 outdoor	R2T35 outdoor
Sizes available*	1, 2, 4	1, 2, 4	2, 4	2, 4
Voltage rating (kV)	15	15	25/28	35
Number of sheds	0	4	6	8
Minimum strike distance in. (mm)	8.4 (213)	11.6 (295)	14.5 (368)	16.8 (427)
Creepage distance in. (mm)	8.4 (213)	15.0 (381)	22.8 (579)	30.0 (762)

\* See page A63 for cable insulation diameter ranges.





## Distribution shrink-fit terminations

### Ranger2 terminations

The R2T and R2IT termination design couples shrink-fit technology and Elastimold's pull-down jacket seal feature to provide a termination line that covers the widest range of applications with the fewest number of models. Three sizes cover 0.64" (16 mm) to 2.10" (53 mm) insulation diameter cables (#2 AWG through 1,250 kcmil).

The R2T housings are designed for maximum performance in all field conditions with superior creepage and strike distances for long-term service. Insulating silicone sleeves are also available when more creepage is required or when wildlife protection is needed to insulate the connectors. Contact your ABB sales representative for further information.



#### Ranger2 terminations base catalog numbers

	kV class	Type	Cable range (insulation diameter)		Concentric neutral and jacketed concentric neutral cable	Tape shield, wire shield and unishield cable	LC shield, wire over tape shield and tape shield cable	Cat. no.
			Inches	mm				
	15	Indoor	0.64 to 1.12	16.3 to 28.4	R2IT15J1	R2IT15M1	R2IT15L1	
			0.84 to 1.38	21.3 to 35.1	R2IT15J2	R2IT15M2	R2IT15L2	
			1.30 to 2.10	33.0 to 53.3	R2IT15J4	R2IT15M4	R2IT15L4	
	15	Outdoor	0.64 to 1.12	16.3 to 28.4	R2T15J1	R2T15M1	R2T15L1	
			0.84 to 1.38	21.3 to 35.1	R2T15J2	R2T15M2	R2T15L2	
			1.30 to 2.10	33.0 to 53.3	R2T15J4	R2T15M4	R2T15L4	
	25/28	Outdoor	0.84 to 1.38	20.3 to 35.1	R2T28J2	R2T28M2	R2T28L2	
			1.30 to 2.10	33.0 to 53.3	R2T28J4	R2T28M4	R2T28L4	
	35	Outdoor	0.84 to 1.38	20.03 to 35.1	R2T35J2	R2T35M2	R2T35L2	
			1.30 to 2.10	33.0 to 53.3	R2T35J4	R2T35M4	R2T35L4	

## Distribution shrink-fit terminations

### Ranger2 terminations

#### Ranger2 termination connector options

	Type	Material	Conductor	Conductor size	Connector prefix*
	Stem compression connector	Aluminum	Aluminum or copper	#2-4/0 (34-107)	T0
		Aluminum	Aluminum only	#2-4/0 (34-107)	T1
	One-hole spade connector	Tinned aluminum	Aluminum or copper	#2-500 (34-253)	H0
	Two-hole spade connector	Tinned aluminum	Aluminum or copper	#2-1250 (34-633)	N0
		Tinned copper	Copper	#2-1250 (34-633)	N2



\* See page A65 for conductor code.

#### Optional cable support brackets

Type	Cable range (overall O.D.)	Cat. no.	Stainless steel	
			Suffix number	
	Single clamp	0.80"-1.25" (20-32 mm)	JB-1	B1
	Single clamp	1.10"-1.50" (28-38 mm)	JB-2	B2
	Double clamp	1.45"-1.95" (37-50 mm)	JB-3	B3
	Double clamp	1.80"-2.40" (45-61 mm)	JB-4	B4

#### Add-on grounding kits

##### Convert a jacketed concentric neutral "J" kit to an "M" or "L" shield kit

	Cat. no.	Type	Size	Use with series
	GMA	Tape shield/wire shield/unishield	A	R2IT15J1, R2IT15J2, R2T15J1, R2T15J2, R2T28J2, R2T35J2
	GMB	Tape shield/wire shield/unishield	B	R2IT15J4, R2T15J4, R2T28J4, R2T35J4
	GLA	LC shield/wire over tape shield	A	R2IT15J1, R2IT15J2, R2T15J1, R2T15J2, R2T28J2, R2T35J2
	GLB	LC shield/wire over tape shield	B	R2IT15J4, R2T15J4, R2T28J4, R2T35J4



# Distribution shrink-fit terminations

## Ranger2 terminations

### Ordering information for Ranger2 terminations

Ranger2 terminations may be ordered in components or as complete kits by following the steps outlined and using the model below to develop the catalog number for your application. Contact your local ABB sales representative for special requirements.

Indicates field that must be filled in to complete order. Note: Availability of selected configuration will be verified at quotation time.

The following diagram shows how to construct a catalog number for a Ranger2 termination.

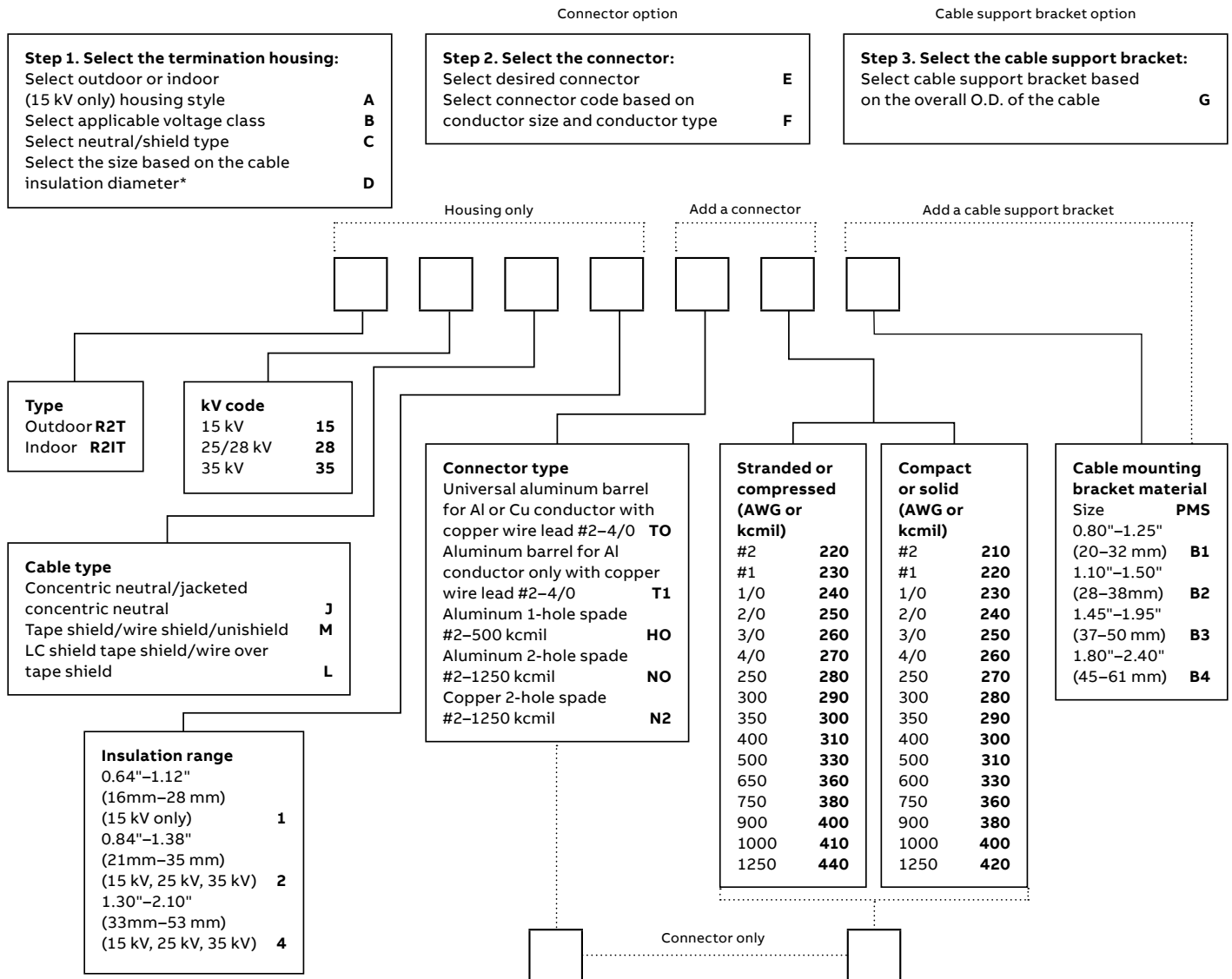

\* To help in selecting the proper terminator, ICEA and AEIC standard dimensions for XLP and EPR cables are on pages A50 to A52.  
 \*\* In 28 kV, the connector type "NO" is only for insulation range 2 and 4.

## Distribution shrink-fit terminations

### Ranger2 terminations

01 Train the cable into position and cut to length. Using standard practices, cut back the cable jacket, metallic shield, semi-conductive shield and cable insulation, exposing the conductor.

02 Finish preparing the metallic shield. For concentric neutral or jacketed concentric neutral cables, bend back the neutral wires and seal with mastic strips and vinyl tape. For metallic tape, drain wire, unshield or LC shield cables: install the ground braid using the constant force spring and seal with mastic strips and vinyl tape.

03 Clean the exposed conductor, install and crimp the connector.

04 Use mastic and vinyl tape to fill any gap or step between the connector and the cable insulation. Clean the cable.

05 Apply a liberal bead of silicone lubricant to the semi-con shield step.

06 Pull the loose end of the core cord until the core is even with the end of the termination housing.

07 Position the terminator onto the cable.

08 Shrink into place by unwinding the removable core.

09 Apply silicone lubricant to skirt and mastic area.

10 Fold down the skirt over the mastic to seal the cable entrance.

11 Seal the top of the terminator at the connector area with silicone tape.

12 Attach the neutral wires or optional ground braid to the system ground per local code. Install the optional cable support bracket if required.

#### Typical installation of Elastimold Ranger2 shrink-fit terminations (R2T – Outdoor and R2IT – Indoor)

**Warning:** Refer to local code for required PPE.



01, 02, 03, 04



05



06



07



08



09



10



11



12

# Overhead faulted circuit indicators

## Fisher Pierce series 1548 overhead FCIs

—  
01 Trip/reset tool  
AT2186-10  
Manual trip/reset test  
for both permanent  
and temporary fault  
indication using  
hotstick-mountable  
reset tool.



—  
01



### Reliable fault indication for single-phase overhead applications.

- Adaptive or fixed current trip with inrush restraint logic
- Adaptive trip logic eliminates the need for tripping selection or revision with changing load
- Automatic reset with return of load current and/or time reset of permanent fault indication
- Automatic time reset for temporary fault indication
- Manual trip test and reset capabilities using hotstick-mountable trip/reset tool
- Visual fault indication choices of LED, 5-LED array, flag or strobe light; highly viewable 360° indication (strobe or LED); radio fault reporting capability also available
- Hotstick mounting with automatic torque limiting
- Replaceable lithium battery offers 10-year, maintenance-free service life (Flag model has non-replaceable battery)
- Mounts on conductors with diameters from 0.14" to 1.20" (3.56 mm to 30.48 mm)
- Options include temporary/permanent fault indication, instantaneous recloser coordination feature and backfeed restraint using a delay-trip scheme (requires protective device to pass two cycles minimum of fault current before closing)

### FCIs with radio transmitters

Series 1548 radio FCIs can signal faults to handheld receivers, radio receivers and the SmartLink® series 5000 cellular remote terminal unit (RTU) systems integrated with SCADA- and web-based reporting systems. Status, alarms and other event notifications can be integrated into SCADA systems, as well as sent to customer-designated personnel via e-mail, pager or text message. Having precise fault information reduces outage duration, improves system reliability and lowers operation costs.

## Overhead faulted circuit indicators

### Specifications

#### System voltage:

- Flag, strobe models: 44 kV max.
- LED, radio models: 69 kV max.

**Continuous withstand load:** 1,000 A max.

**Operating temperature:** -40 °C to 85 °C

**Reset time accuracy:** ±10% at 23 °C

**Current reset:** 3 A or 8 A min. (model specific)

**Fixed trip current level:** 50 to 1,500 A

**Adaptive trip:** 100 di/dt, 300 di/dt

**Fault withstand:** 25 kA for 10 cycles  
(per ANSI/IEEE 495-1986)

**Trip accuracy:** ±10% at 23 °C

**Battery:** Replaceable 10-yr. lithium cell  
(flag model non-replaceable)

#### Battery operating life at 23 °C:

- Single ultra bright LED & flag: 1,000 operating hrs.
  - 5 red LEDs: 400 operating hrs.
  - Strobe: 120 operating hrs.
  - Radio with LED: 800 operating hrs.
- Temporary fault model:**
- 1 amber (temporary fault) LED: 1,500 operating hrs.
  - 4 red (permanent fault) LEDs: 400 operating hrs.

**Housing:** Semi-conductive UV-stable polycarbonate

**Cable diameter:** 0.14" to 1.2"  
(3.56 mm to 30.48 mm)

#### Certifications:

- Complies with ANSI/IEEE 495-1986

### Mechanical data

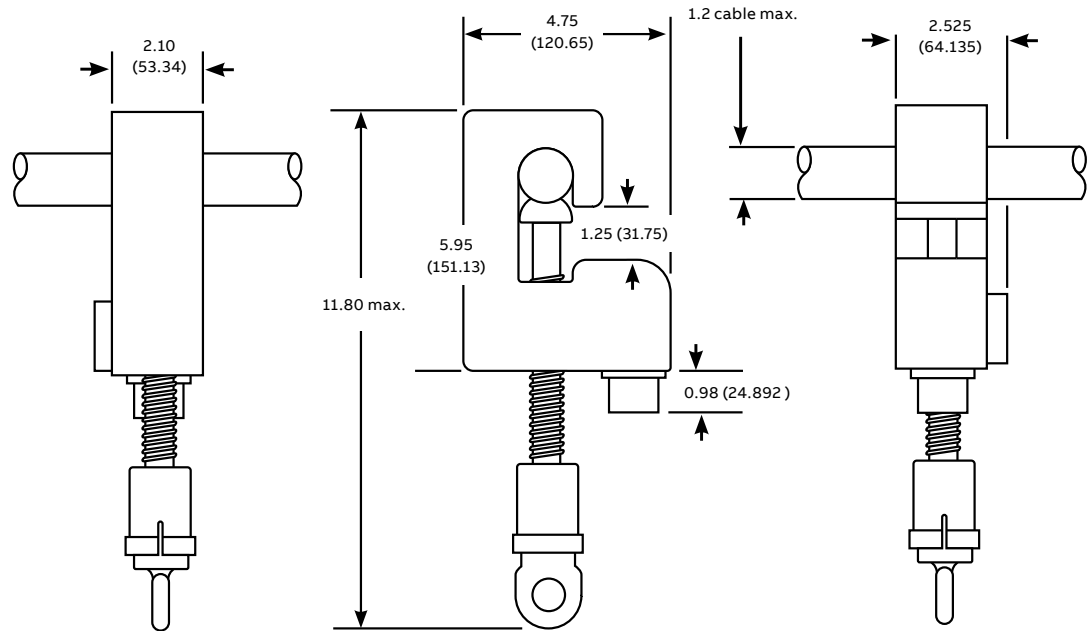

(All dimensions in inches with millimeter equivalents in parentheses)

# Underground faulted circuit indicators

## Specifications

**Fault registration:** Red, high-intensity LED with choice of hard-wired or fiber optic cable remote mounting or audible intermittent beeper signal

**Trip current:** Factory preset to customer specifications within range of 50 A and 100 A to 1,500 A in 100 A increments

**Trip current accuracy:** ±10% of trip rating (calibrated using 1" dia. cable for 400 A trip or less or 2.0" dia. cable for greater than 400 A trip)

**Trip response speed:** Consult trip curves (coordinated to properly applied link, expulsion, power and current-limiting fuses)

**Reset time:** 4 hrs., 2 hrs., 1 hr., manual trip/reset standard

**Overload capacity:** Capable of withstanding 25,000 A for 10 cycles

**Continuous load current:** Rated at 1,000A max.

**Temperature range:** -40 °C to 85 °C

**Submersibility:** Tested to 30 ft.

**Operating battery life:** 800 hrs. for LED indication, 160 hrs. for audible indication, both with 10-yr. life at 20 °C

**Battery:** Long-life lithium cell

**Cable ranges:** 0.63" (16 mm) to 1.58" (40 mm); 1.58" (40 mm) to 2.36" (60 mm); 2.36" (60 mm) to 3.55" (90 mm)

**Remote fiber optic options:** Permanent or removable (10 ft. standard, 30 ft. max.)

**Certifications:** Complies with ANSI/IEEE 495-1986

The following diagram shows how to construct a catalog number for the Series 1541/1542/1543 FCIs. Not all combinations are possible. Consult factory for ordering assistance.

Indicates field that must be filled in to complete order.  
 Note: Availability of selected configuration will be verified at quotation time.

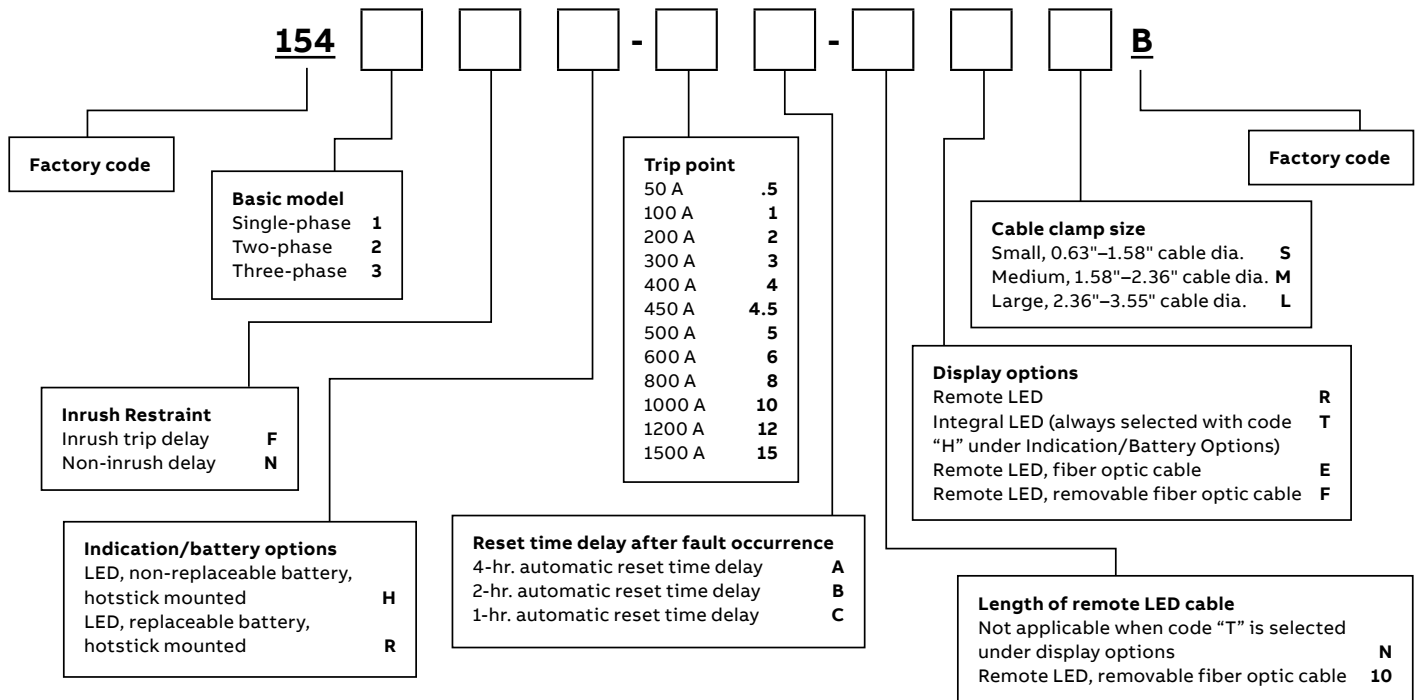

## Test point indicators

### Fisher Pierce TPM series test point fault indicators



#### Mount directly to any IEEE 386 standard capacitive test point.

- AccQTrip™ logic circuitry prevents false indications in voltage-reset units due to inrush currents, cold load pickup and overloading
- High/low trip-setting selection requires no minimum load current and no load surveys
- Internal magnetic shielding prevents adjacent phase effects
- 1-msec. trip response coordinates with current-limiting fuses, as well as other protection devices
- Magnetically latched flag prevents flag indication from changing state due to shock or vibration
- Mounts directly to 200 A and 600 A elbows, splices and other cable accessories equipped with IEEE 386 standard capacitive test points from Fisher Pierce and other manufacturers
- Built-in pulling eye enables safe, easy hotstick installation and removal from test points
- Enclosed in a rugged, yet lightweight and compact, sealed, impact- and corrosion-resistant Lexan® housing with EPDM molded-rubber test point mounting boot

Fisher Pierce test point mounted fault indicators consist of a solid-state current sensor connected to a faulted-circuit display, providing a clear visual means for quickly locating faulted cables and equipment on underground distribution systems. Designs incorporate advanced circuit logic and monitoring system protection operation to prevent the indicator from tripping unless an overcurrent condition is followed by a loss of system voltage. Trip and reset operations are automatic, and for versatility and convenience, the same indicator may be used for 5 kV thru 35 kV applications.

#### Basic operation

A faulted circuit produces an associated magnetic field, which closes a reed switch in the indicator, resulting in a tripped display. Trip response occurs in 0.001 seconds (1 msec.), allowing the fault indicator to properly coordinate with all types of circuit-protection schemes, including current-limiting fuses. To eliminate confusing false trips, voltage-reset indicators are equipped with inrush, backfeed, overload and cold-load pick-up restraint circuitry. Current sensors feature internal shielding to prevent inadvertent tripping when located in close proximity to adjacent phases, such as in junction-mounted applications.

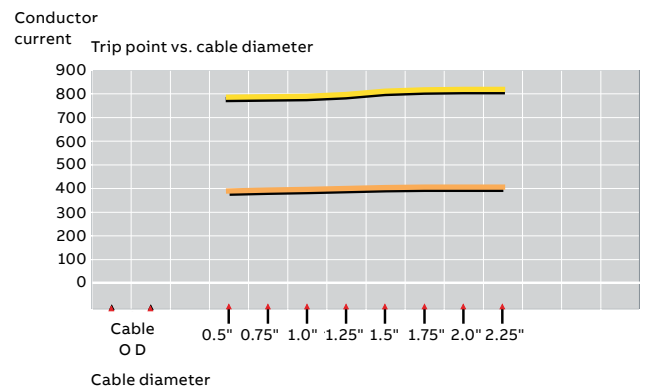
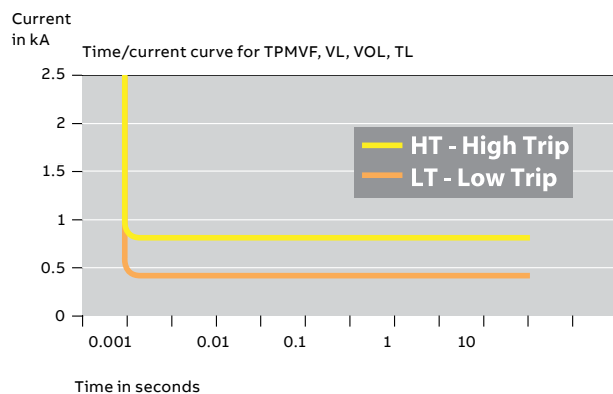

## Test point indicators

### Mechanical data



### Fisher Pierce® TPM series test point fault indicators

Cat. no.	Description
TPMTL-[ _ ]	Time reset with LED display (auto-resets to normal after 4 hrs.; may also be manually reset using an FTT test tool)
TPMVF-[ _ ]	Voltage reset with flag display (auto-resets to normal after system voltage restoration; reset requires 5 kV min. voltage with time required for reset proportional to system voltage)
TPMVL-[ _ ]	Voltage reset with LED display (auto-resets to normal after system voltage restoration; reset requires 5 kV min. voltage with time required for reset proportional to system voltage)
TPMVOL-[ _ ]	Voltage operated, time reset, LED display (auto-resets after 4 hrs.; longer time resets available upon request)
Cat. no. suffix	Description
-LT	For 200 A. All fused taps use LOW trip rating. For URD applications, use LOW trip rating.
-HT	For 600A. For URD applications, use HIGH trip rating.

Note: For overhead bulk feeder applications, use HIGH or LOW trip ratings (whichever is greater than the minimum pickup setting of the related protection device). AccQTrip and AccQClamp™ are trademarks of Quality Indications, Inc.

### Dimensions

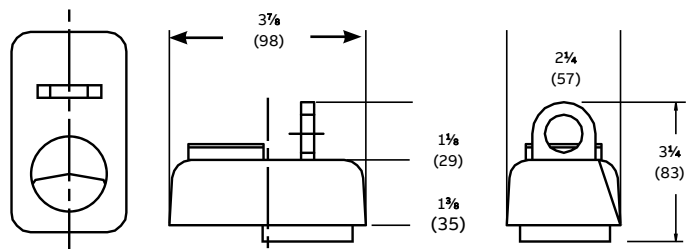

(All dimensions in inches with millimeter equivalents in parentheses)

## Clamp-type faulted circuit indicators

Fisher Pierce series OLM overhead line fault indicators

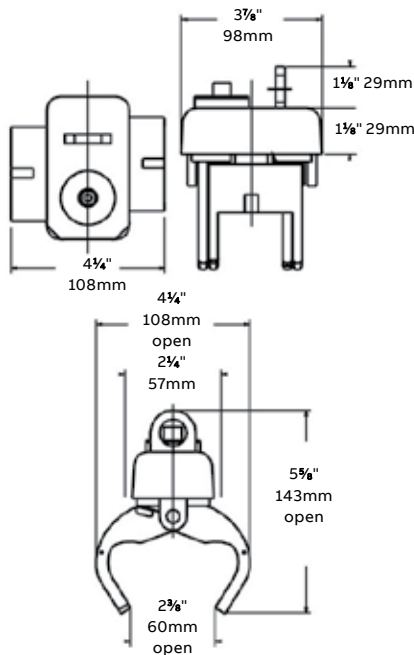

### Locate faulted circuits and equipment on overhead distribution systems.

- AccQTrip logic circuitry in voltage reset units prevents false indications due to inrush currents, cold load pickup and overloading
- AccQClamp mounting provision – Universal one-size-fits-all design automatically adjusts
- High/low trip setting selection eliminates minimum load current and the need for load surveys
- Trip response of 0.001 seconds coordinates with current-limiting fuses, as well as other protection devices
- Internal magnetic shielding prevents adjacent phase effects
- Magnetically latched flag indication – Flag indication will not change states due to shock or vibration
- Compact and sealed lightweight enclosure

Self-powered Fisher Pierce series OLM Overhead line fault indicators consist of a solid-state current sensor connected to a faulted circuit display. Advanced circuit logic monitors system protection operation and prevents indicator tripping unless an overcurrent condition is followed by a loss of system voltage. Trip and reset operations are automatic, and the same indicator may be used for 5 kV thru 35 kV line-to-ground applications.

These compact, sealed and corrosion-resistant units are designed for direct installation to an overhead line using a spring-loaded, over-center toggle clamp. Equipped with retainer pads to prevent slip and twist, the clamp positions the conductor at a constant distance from the current sensor, maintaining trip accuracy over the entire conductor diameter range of 0.4" to 2.2".



# Clamp-type faulted circuit indicators

## Basic operation

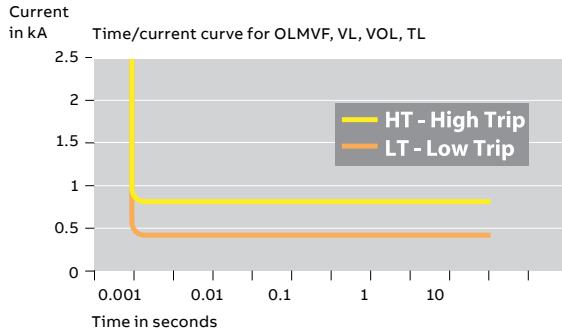

### Basic operation

A faulted circuit produces a magnetic field, which closes a reed switch in the indicator and causes a tripped display. A trip response time of 0.001 seconds enables the indicator to properly coordinate with all circuit-protection schemes, including current-limiting fuses.

To eliminate confusing false trips, indicators feature inrush, overload and cold-load pick-up restraint circuitry as standard. Internal shielding of current sensors prevents inadvertent tripping when in close proximity to adjacent phases.

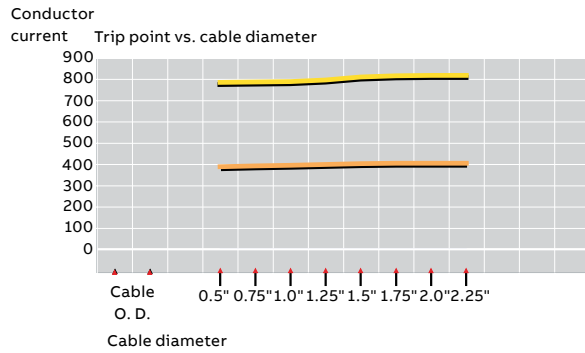

## Test point indicators

### Series OLM overhead line fault indicators

#### Series OLM overhead line fault indicators

Cat. no. prefix	Description	Reset operation
OLMTL	Time reset with LED display	Indicator auto-resets to normal after a four-hour time duration. Indicator may also be manually reset using an FTT test tool.
OLMVF	Voltage reset with flag display	Indicator auto-resets to normal after system voltage restoration. Reset requires 5k V minimum voltage to operate. Reset operation time is proportional to system voltage.
OLMVL	Voltage reset with LED display	Example: at 15 kV, reset occurs 30 seconds after system voltage restoration.
OLMVOL	Voltage operated, time reset, LED display	Indicator auto-resets after a four-hour time duration. Longer time resets are available upon request.

Cat. no. suffix	Description
LT	All fused taps use LOW trip rating for 200 A. Overhead applications, use LOW trip rating.
HT	For 600 A. Overhead applications, use HIGH trip rating.

### Accessories for series TPM, UCM and OLM fault indicators



#### FTT (Field test tool)

Permits field testing and reset of fault indicators and provides assurance that the indicator is properly functioning. The test tool is lightweight, portable and incorporates a built-in magnet which operates the indicator trip and reset functions. The unit is equipped with provisions for hotstick handling and operation.

#### FO-Cable06

Remote fiber optic indicator for underground fault indicators with LED display can be extended to the outside of enclosures and/or vaults for ease of access and fault location. All the hardware for mounting the remote end of the cable to the enclosure is included. The display has a large reflective bolt to enhance visibility.

#### Fault indicator accessories

Cat. no.	Description
FTT	Field test tool, overall dimensions 2" wide x 3" high x 5/8" deep
FO-CABLE06	Remote fiber optic indicator for UFI

## Test point indicators

### V2 Voltage indicator



#### Easy way to visually determine the energized status of underground distribution circuits.

- Single model supports applications from 5 kV to 35 kV
- Flash rate per minute indicates system voltage (see chart on following page)
- Mounts to 200 A and 600 A elbows, splices and other cable accessory components equipped with IEEE 386 capacitive test points from Fisher Pierce or other manufacturers
- Molded EPDM rubber housing for shielded, sealed and corrosion-resistant construction
- Built-in pulling eye enables safe, easy hotstick installation and removal from test point
- 20-year neon bulb yields long, maintenance-free service life
- Easily tested for confirmation of proper operation with the V2-TB voltage indicator test box

The V2 voltage indicator consists of a self-powered voltage sensor connected to a neon light that flashes when energized. Simply plug it into any IEEE 836 standard capacitive test point to determine the energized status of underground distribution circuits. Because the flash rate is proportional to the phase-to-phase system voltage, as indicated in the chart, one V2 model supports a wide range of applications — from 5 to 35 kV.

## Test point indicators

### Mechanical data

Voltage (kV)	Flash rate
5	20
10	40
15	70
20	100

Voltage (kV)	Flash rate
25	140
30	160
35	180

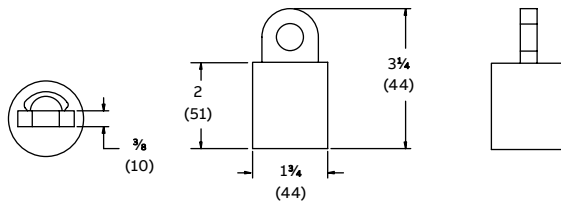

(All dimensions in inches with millimeter equivalents in parentheses)



### V2-TB test box for easy field testing of V2 voltage indicators.

If the V2 neon voltage indicator indicates a power failure in an underground distribution circuit, you'll want to ensure that it's actually the circuit that's failed and not the V2 itself. For fast, simple assurance, field test the V2 with the compact, portable V2-TB voltage indicator test box, powered by replaceable C batteries.

### V2 voltage indicator – Test point mounted

Cat. no.	Description
V2	Voltage indicator with neon display
V2-TB	Voltage indicator test box

# Underground distribution switchgear

## Molded vacuum switches and fault interrupters



### MVS molded vacuum switches

Spring-energy, load-switching devices that make, carry and interrupt load currents through 600 A on 5 to 38 kV distribution systems.

MVS molded vacuum switches include molded-in elbow connection interfaces and spring-energy mechanisms. Available in both single- and three-phase models, units are manually operated with a hotstick. Motor operator, SCADA and auto-transfer control options are available.

- EPDM molded rubber insulation — MVSs are fully sealed and submersible.
- Vacuum switching and vacuum — Interruption Components are maintenance-free and require no gas or oil.
- Compact and lightweight — Small footprint enables MVSs to fit in tight padmount, subsurface, vault or riser pole installations.

Single-phase switches approximate weight: 30 lbs.

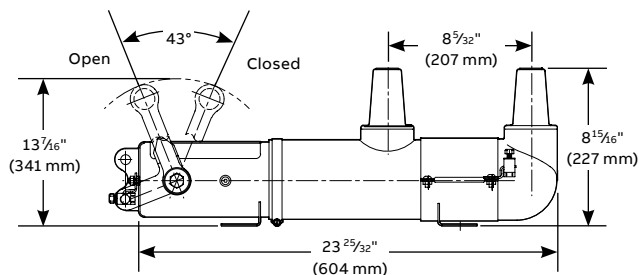
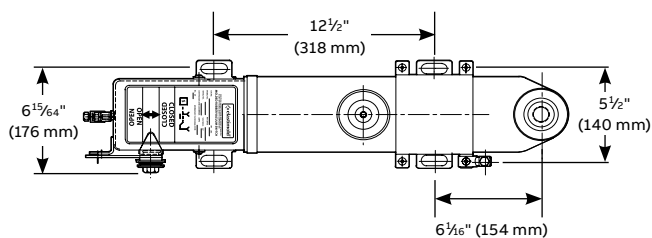
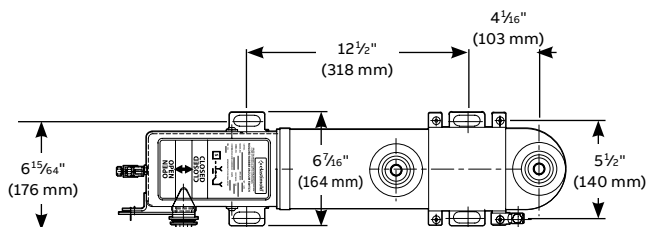

(4) Mounting holes, 5/8" dia. x 7/8" (16 x 22 mm)

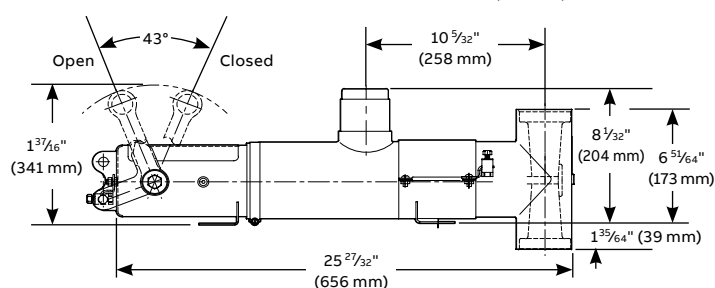

(4) Mounting holes, 5/8" dia. x 7/8" (16 x 22 mm)

Available with 600 A one-piece bushings or 200 A wells on either/both terminals.

# Underground distribution switchgear

## MVS molded vacuum switches

Three-phase switches approximate weight: 135 lbs.

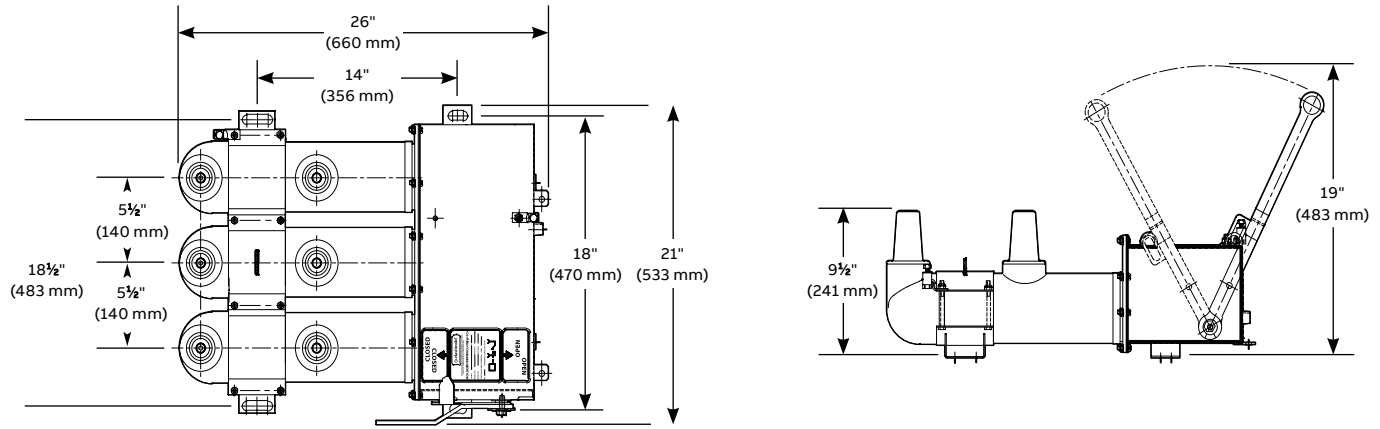

Available with 600 A one-piece bushings or 200 A wells on either/both terminals.

### Ratings

Maximum design voltage (kV)	15.5	27	38
Frequency (Hz)	50/60	50/60	50/60
BIL impulse (kV)	95	125	150
One-minute AC withstand (kV)	35	60	70
Fifteen-minute DC withstand (kV)	53	78	103
Load interrupting & loop switching (Amp)	600	600	600
Transformer magnetizing interrupting (Amp)	21	21	21
Capacitor or cable charging interrupting (Amp)	40	40	40
Asymmetrical momentary and 3-operation fault close (Amp)	20	20	20
Symmetrical one-second rating (Amp)	12,5	12,5	12,5
Continuous current (Amp)	600	600	600
Eight-hour overload current (Amp)	900	900	900

### Application information

- Construction: Submersible, corrosion resistant, fully shielded
- Ambient temperature range: -40 °C to 65 °C

### Certified tests

MVS loadbreak switches have been designed and tested per applicable portions of IEEE, ANSI, NEMA and other industry standards, including:

- IEEE C37.74** standard for subsurface, vault and padmounted load-interrupting switches
- IEEE 386** standard for separable connectors and bushing interfaces
- IEC 265** international standards for load-interrupting switches
- ANSI C57.12.28** standard for padmount enclosures

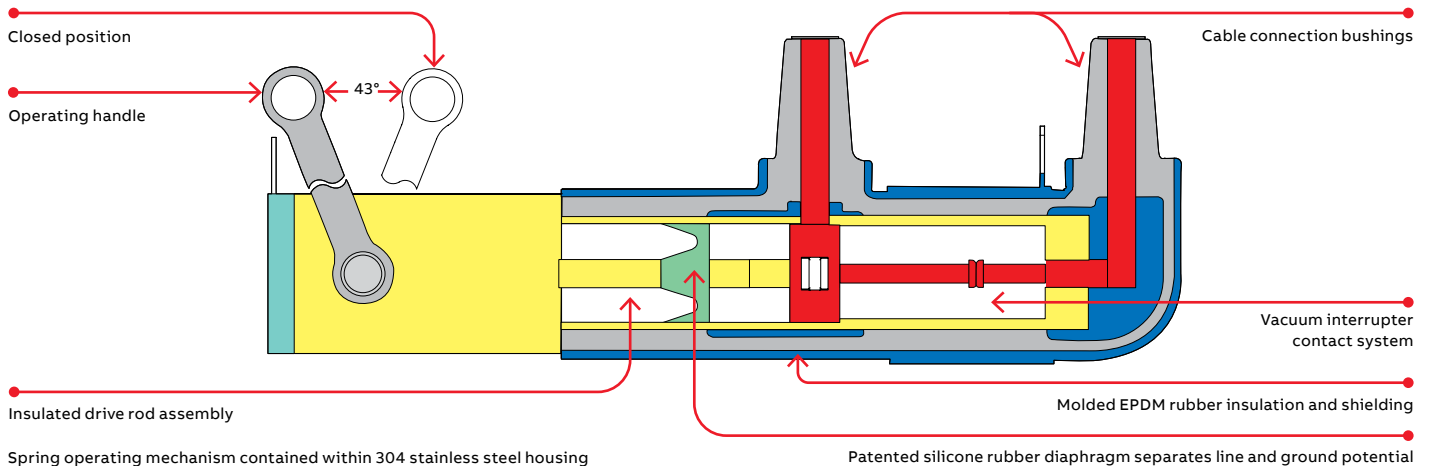

## Underground distribution switchgear

### MVI molded vacuum fault interrupters

Make, carry and automatically interrupt currents through 25,000 A symmetrical on 5–38 kV distribution systems.

- Vacuum interrupters, programmable, electronic, self-powered controls and EPDM rubber insulation provide compact, lightweight and submersible overcurrent protection
- Field programmable with a wide range of time-current characteristic (TCC) curves and trip settings
- TCC curves provide predictable tripping for ease of coordination with upstream and/or downstream protective devices
- Control monitors the circuit condition – when the programmed parameters are exceeded, a signal is sent to the tripping mechanism
- Available motor operators and controls enable radial feeders or loops to be reconfigured, either manually or via SCADA

MVI molded vacuum fault Interrupters include molded-in elbow connection interfaces and trip-free mechanisms. They are available in single- and three-phase models.

#### Application information

Construction: submersible, corrosion resistant, fully shielded

Operating temperature range: -40 °C to 65 °C

For dimensions, see page A81.



# Underground distribution switchgear

## MVI molded vacuum fault interrupters

### Certified tests

MVI molded vacuum fault interrupters have been designed and tested per applicable portions of IEEE, ANSI, NEMA and other industry standards, including:

ANSI C37.60	Standard for fault interrupters
IEEE 386	Standard for separable connectors and bushing interfaces
ANSI C57.12.28	Standard for padmounted enclosures

### MVI ratings

Voltage class (kV)	15	15	15	27	35	35
Maximum design voltage (kV)	17	17	15.5	29	38	38
Frequency (Hz)	50/60	50/60	50/60	50/60	50/60	50/60
BIL impulse (kV)	95	95	95	125	150	150
One-minute AC withstand (kV)	35	35	35	40	50	50
15-minute DC withstand (kV)	53	53	53	78	103	103
Load interrupting and loop switching (Amp)	630	630	630	630	630	630
Capacitor or cable charging interrupting (Amp)	10	10	10	25	40	40
Line charging (Amp)	2	2	2	5	5	5
Asymmetrical momentary and 3-operation fault close (Amp)	20,000	25,600	32,000	20,000	20,000	40,000
Symmetrical one-second rating (Amp)	12,500	16,000	20,000	12,500	12,500	25,000
Continuous current (Amp)	630	630	630	630	630	630
Eight-hour overload current (Amp)	900	900	900	900	900	900
Current sensor ratio	1,000:1	1,000:1	1,000:1	1,000:1	1,000:1	1,000:1
Mechanism	Spring operating	Spring operating	Spring operating	Spring operating	Spring operating	Mag actuator

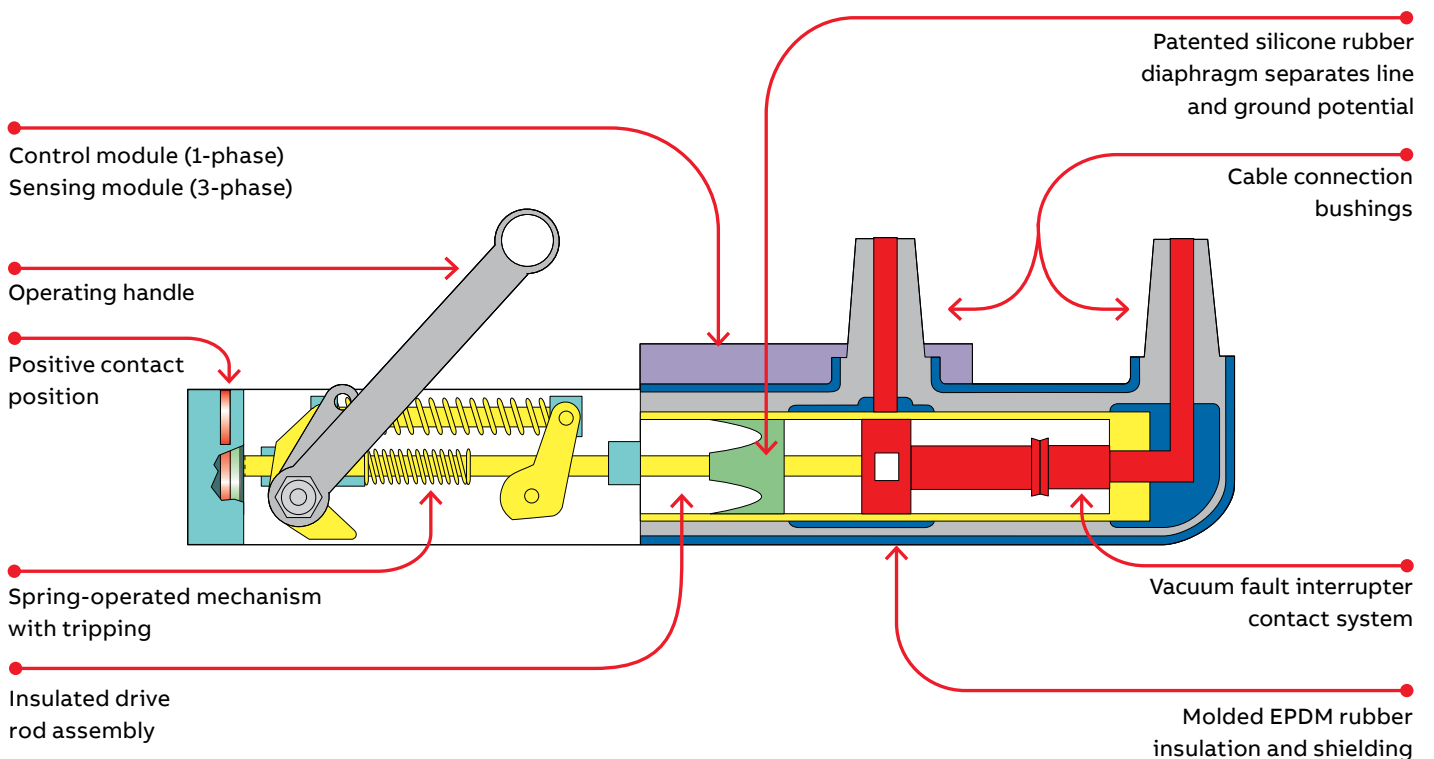



# Underground distribution switchgear

## MVI molded vacuum fault interrupters

### Front view single-phase

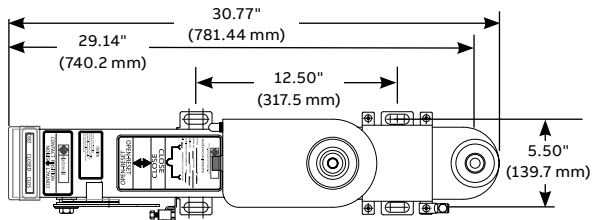

### Front view three-phase

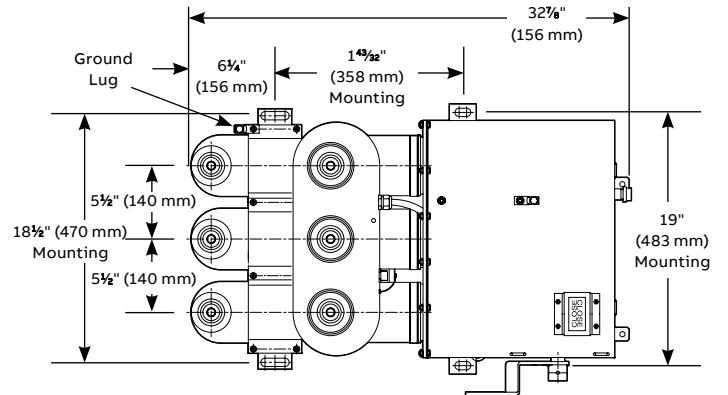

### 200 A wells

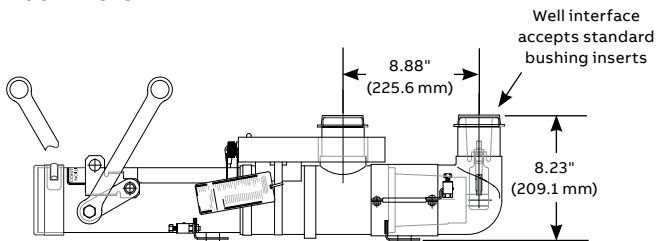

### 600 A bushings

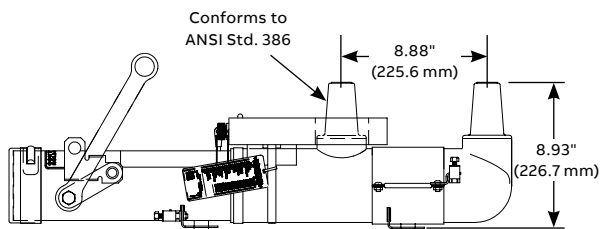

### 600 A T elbow interface

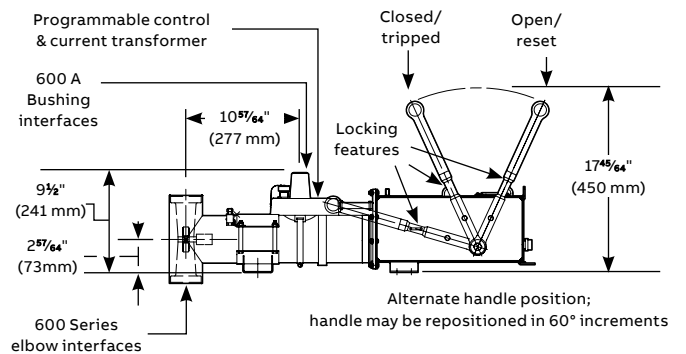

## Molded vacuum interrupter and switchgear controls

Choose among various electronic control options to interrupt faults

- 01 Internal control
- 02 External control

- Self-powered electronic control packages – No batteries or external power are required
- Controls send a signal to the vacuum interrupters to trip open and interrupt the fault when an overcurrent condition is detected
- Field-selectable fuse or relay curves and trip settings – one device for many protection schemes

Molded vacuum interrupters are provided with self-powered electronic control packages requiring no batteries or external power. Depending on the application, six electronic control options are available for the MVI – See below and on following page.



01



02

### Internal control

This control is integral to the unit (no separate control box). It is accessible via a computer connection to view or modify settings. This control is used on ganged three-phase or single-phase MVI interrupters. Phase and ground trip, as well as inrush restraint, are available. The E-Set software enables the user to connect to the internal control, either in the shop or in the field, to program or change settings. An MVI-STP-USB programming connector is required to connect between the PC and the MVI. With a computer connected to the MVI control, the user can view real-time currents, the number of overcurrent protection operations, current magnitude of the last trip and the phase/ground fault targets. This is the standard control option.

Note: E-Set can be downloaded from [www.elastimoldswitchgear.com](http://www.elastimoldswitchgear.com).

### External control with selectable single-/three-phase trip function (style 80)

This control is mounted externally to the mechanism of the interrupter and provides the ability to select between a single-phase trip and a three-phase trip. The 80 can be used with one three-phase interrupter or the 380 control with three single-phase interrupters. For three-phase applications, the ground trip function can be blocked from the front panel. Manual trip and reset target buttons are also located on the front panel. This control uses the E-Set software, which enables programming via a computer using the MVI-STP-USB adapter. E-Set features custom TCC curves and provides access to the last fault event information, as well as real-time current per phase.

## Molded vacuum interrupter and switchgear controls

—  
01 SEL-751A  
Feeder protection

—  
02 SEL-451  
Automation and  
auto-transfer controls  
(standard and fast  
transfer options)



—  
01



—  
02

### Smart grid ready

Works with the industry-leading protection and automation controls

- SEL automation controls from Schweitzer Engineering Laboratories

### Elastimold 80 control time current curves (TCCs)

Curve no.	Curve reference no.	Curve type
<b>Relay curves (minimum trip 30–600 A)</b>		
01	MVI-TCC-01	E slow
02	MVI-TCC-02	E standard
03	MVI-TCC-03	Oil fuse cutout
04	MVI-TCC-04	K
05	MVI-TCC-05	Kearney QA
06	MVI-TCC-06	Cooper EF
07	MVI-TCC-07	Cooper NX-C
08	MVI-TCC-08	CO-11-1
09	MVI-TCC-09	CO-11-2
10	MVI-TCC-10	T
11	MVI-TCC-11	CO-9-1
12	MVI-TCC-12	CO-9-2
13	MVI-TCC-13	Cooper 280ARX
14	MVI-TCC-14	F
16	MVI-TCC-16	Kearney KS
17	MVI-TCC-17	GE relay
18–23	MVI-TCC-18–23	CO-8-1–CO-8-6
24–27	MVI-TCC-24–27	CO-9-3–CO-9-6
28–31	MVI-TCC-28–31	CO-11-3–CO-11-6
<b>Fuse curves (minimum trip 10–200 A)</b>		
54	MVI-TCC-54	E slow
55	MVI-TCC-55	E standard
56	MVI-TCC-56	Oil fuse cutout
57	MVI-TCC-57	K
58	MVI-TCC-58	Kearney QA
59	MVI-TCC-59	Cooper NX-C
60	MVI-TCC-60	T

## Ordering information

### Elastimold MVS and MVI units

The following diagram shows how to construct a catalog number for molded vacuum switches and interrupters.

**Example:** The catalog number for a molded vacuum interrupter on a three-phase, 27 kV system, with 600 A terminal and parking stands between bushings is MVI3212766PS.

Indicates field that must be filled in to complete order.

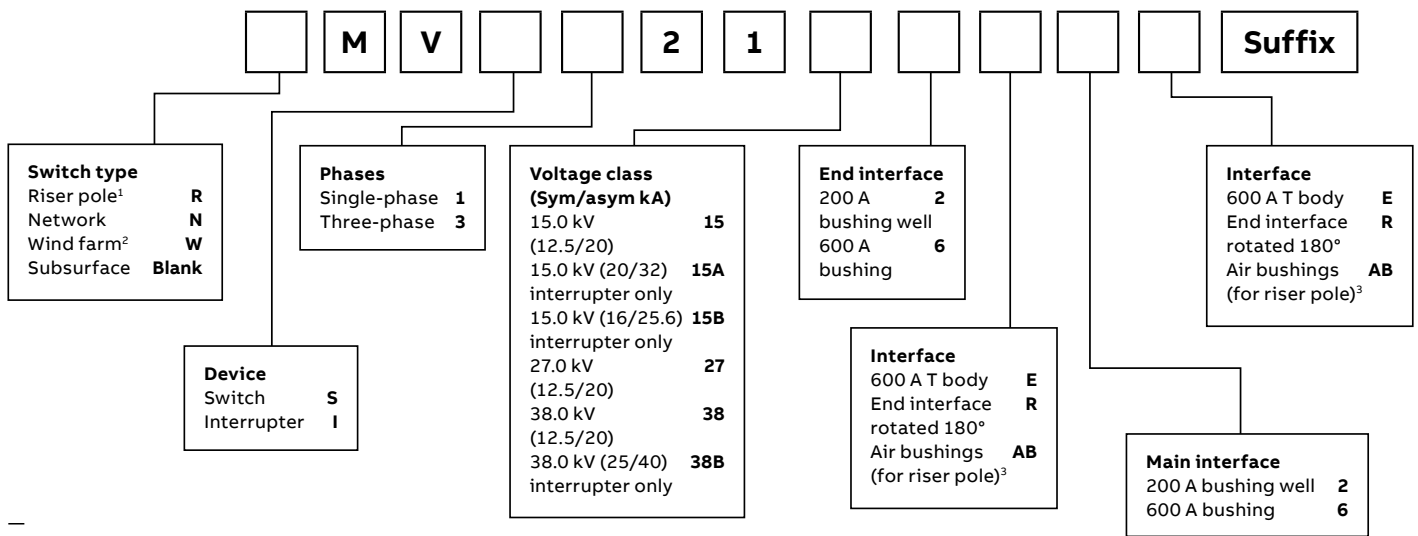

1) For riser pole option, specify where to locate air bushings.  
 2) Wind farm option is only for 38 kV, 600 A interrupter.  
 3) Air bushings can only be specified for 600 A.

### Controls and accessories

Suffix	Description
80	External 80 control with selectable single-/three-phase trip function (to be used on ganged three-phase MVI mechanism)
380	External 80 control with selectable single-/three-phase trip function (to be used on three single-phase mechanisms)
MO120A	120 V AC motor controller for MVS3 or MVI3 units (includes standard 30-ft. cable)
MO12D	12–24 V DC motor controller for MVS3 or MVI3 units (includes standard 30-ft. cable)
PS	Parking stand for MVS or MVI (between bushings for single- or three-phase units)
MPS	Parking stand for MVS3, MVI3 or RMVI3 on mechanism cover
PS6	Double parking stand for MVS3, MVI3 or RMVI3 (between bushings and on mechanism cover)
BT	Bail tab plate installed for three-phase units only
P	Customer settings to be programmed at the factory

NOTE: Leave suffix blank for internal (self-contained) control.

## Underground distribution switchgear

### Molded vacuum switches and fault interrupters

#### Elastimold MVI molded vacuum interrupters\*\*\*

Cat. no.	Description	Width in. (mm)	Height in. (mm)	Depth in. (mm)	Weight lb. (kg)	Diagram
<b>Riser pole (three-phase installations only)</b>						
RMVI3-21-15-6ABX-YY	15 kV 2-way 3-phase interrupter with air bushings on top terminals	30 (762)	45 (1,143)	25 (635)	150 (68)	)
RMVI3-21-27-6ABX-YY	25 kV 2-way 3-phase interrupter with air bushings on top terminals	30 (762)	45 (1,143)	25 (635)	150 (68)	
RMVI3-21-38-6ABX-YY	38 kV 2-way 3-phase interrupter with air bushings on top terminals	30 (762)	45 (1,143)	25 (635)	150 (68)	
RMVII-21-15-6ABX-3YY	15 kV 2-way 3-phase interrupter with air bushings on top terminals, 1-phase trip selectable	30 (762)	45 (1,143)	25 (635)	150 (68)	
RMVII-21-27-6ABX-3YY	27 kV 2-way 3-phase interrupter with air bushings on top terminals, 1-phase trip selectable	30 (762)	45 (1,143)	25 (635)	150 (68)	
RMVII-21-38-6ABX-3YY	38 kV 2-way 3-phase interrupter with air bushings on top terminals, 1-phase trip selectable	30 (762)	45 (1,143)	25 (635)	150 (68)	
<b>Subsurface single-phase vacuum switches</b>						
MVI1-21-15-XX	15 kV 2-way 1-phase interrupter	6 (152)	31 (787)	9 (229)	45 (20)	)
MVI1-21-15-6EX	15 kV 2-way 1-phase interrupter, elbow interface	6 (152)	31 (787)	11 (279)	45 (20)	
MVI1-21-27-XX	27 kV 2-way 1-phase interrupter	6 (152)	31 (787)	9 (229)	45 (20)	
MVI1-21-27-6EX	27 kV 2-way 1-phase interrupter, elbow interface	6 (152)	31 (787)	11 (279)	45 (20)	
MVI1-21-38-XX	38 kV 2-way 1-phase interrupter	6 (152)	31 (787)	9 (229)	45 (20)	
MVI1-21-38-6EX	38 kV 2-way 1-phase interrupter, elbow interface	6 (152)	31 (787)	11 (279)	45 (20)	
<b>Subsurface three-phase vacuum switches</b>						
MVI1-21-15-XX-3YY	15 kV 2-way 3-phase interrupter, 1-phase trip selectable ext. control	20 (508)	31 (787)	9 (229)	145 (66)	)
MVI1-21-27-XX-3YY	27 kV 2-way 3-phase interrupter, 1-phase trip selectable ext. control	20 (508)	31 (787)	9 (229)	145 (66)	
MVI1-21-38-XX-3YY	38 kV 2-way 3-phase interrupter, 1-phase trip selectable ext. control	20 (508)	31 (787)	9 (229)	145 (66)	
MVI3-21-15-XX-YY	15 kV 2-way 3-phase interrupter	20 (508)	33 (838)	10 (254)	145 (66)	
MVI3-21-27-XX-YY	27 kV 2-way 3-phase interrupter	20 (508)	33 (838)	10 (254)	145 (66)	
MVI3-21-38-XX-YY	38 kV 2-way 3-phase interrupter	20 (508)	33 (838)	10 (254)	145 (66)	

\*\*\* Air bushings on top terminal.

#### Accessories (order separately)

Cat. no.	Description
MVI-STP-USB	Adapter for connection between MVI units with internal control and a computer for programming/viewing settings
MV1PMB	Pole-mounting bracket for 1-phase units only
MV3PMB	Pole-mounting bracket for 3-phase units only
MV3HPMB	Horizontal pole-mounting bracket for 3-phase units only
MV13PMB	Pole-mounting bracket for three 1-phase units only
35AL-11	Connector bare wire type $\frac{3}{4}$ "-16 rod for riser pole units; qty. Of 1 needed per phase
35AL-12	Connector 2-hole spade type $\frac{3}{4}$ "-16 rod for riser pole units; qty. Of 1 needed per phase

Notes: Weights and dimensions are approximate.

X = 6 for 600 A or 2 for 200 A or 6E for 600 A T interface.

Y = 10, 20, 30, 80 for different electronic controls.

Leave blank for internal (self-contained) control.

Accessories should be added as suffix to the main catalog number unless otherwise noted.

Other configurations are available. Please consult your local representative on configurations not shown here.

The 3-phase vacuum interrupters are motor-ready.

## Underground distribution switchgear

Elastimold multi-way switchgear and transfer packages

- 01 Subsurface-style unit
- 02 Vault-style unit
- 03 Padmount unit (load side)

### Multi-way unit construction

Multi-way vault and padmount units are built using MVS and MVI modules as required by the application. These are mounted onto the ES multi-way common bus system and assembled on a free-standing, floor-mounted frame. At this stage, the product is ready to be used in vault installations.

For padmount installations, a double-sided, drop-over, painted, mild steel enclosure is provided. Munsell Green 7GY 3.29/1.5 is the standard enclosure color. Other colors are available upon request. Painted stainless steel or fiberglass enclosures are available as options.



—  
01



—  
02

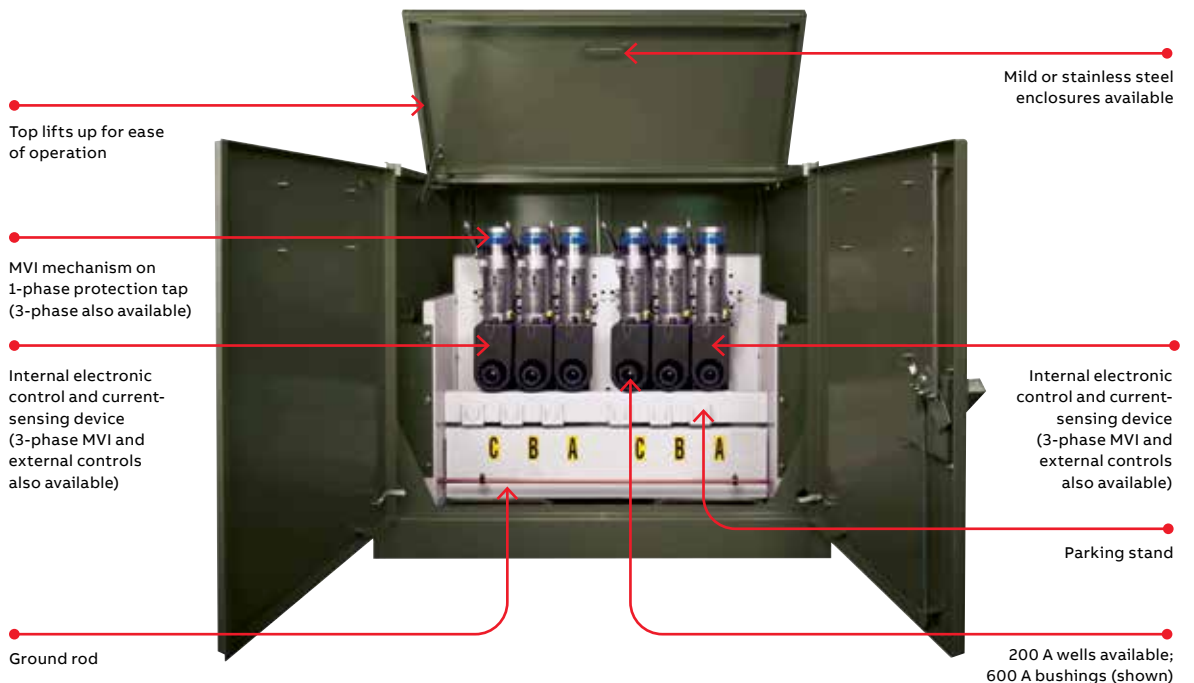

—  
03

Top lifts up for ease of operation

MVI mechanism on 1-phase protection tap (3-phase also available)

Internal electronic control and current-sensing device (3-phase MVI and external controls also available)

Ground rod

Mild or stainless steel enclosures available

Internal electronic control and current-sensing device (3-phase MVI and external controls also available)

Parking stand

200 A wells available; 600 A bushings (shown)

—  
03

# Underground distribution switchgear

## Elastimold multi-way switchgear and transfer packages

The following diagram shows how to construct a catalog number for multi-way switchgear or transfer packages.

**Example:** Multi-way switchgear  
**MD3142T2P62XIXXAE000:** Multi-way, double-sided padmount, 3-phase, 15.0 kV, 95 kV BIL, 12.5 kA interrupting capability, 4-ways, 2 source ways, source component: three-phase molded vacuum switches (MVS3), 2 load ways, load component: three-phase molded vacuum interrupter (MVI3), 600 A bushing interfaces (source), 200 A bushing well interfaces (load), source control: none, load control: Elastimold MVI internal control, PT: PT not required, enclosure: mild steel, Munsell green 7GY 3.29/1.5 and flat ground bar, English labels and instructions.

**Example:** Auto transfer switchgear with SEL control package  
**TD3242H2P62GHFXAE000:** Automatic transfer, double-sided padmount, 3-phase, 27.0 kV, 125 kV BIL, 12.5 kA interrupting capability, 4-ways, 2 source ways, source component: three-phase molded vacuum switches (MVS3) with 12–24 V DC motor and voltage sensors, 2 load ways, load component: three-phase molded vacuum interrupter (MVI3), 600 A bushing interfaces (source), 200 A bushing well interfaces (load), source control: sel 451-5 relay, load control: SEL 751A relay, PT: two (2) 27 kV PT (13200–14400 V AC (WYE), enclosure: mild steel, Munsell green 7GY 3.29/1.5 and flat ground bar, English labels and instructions.

Indicates field that must be filled in to complete order.

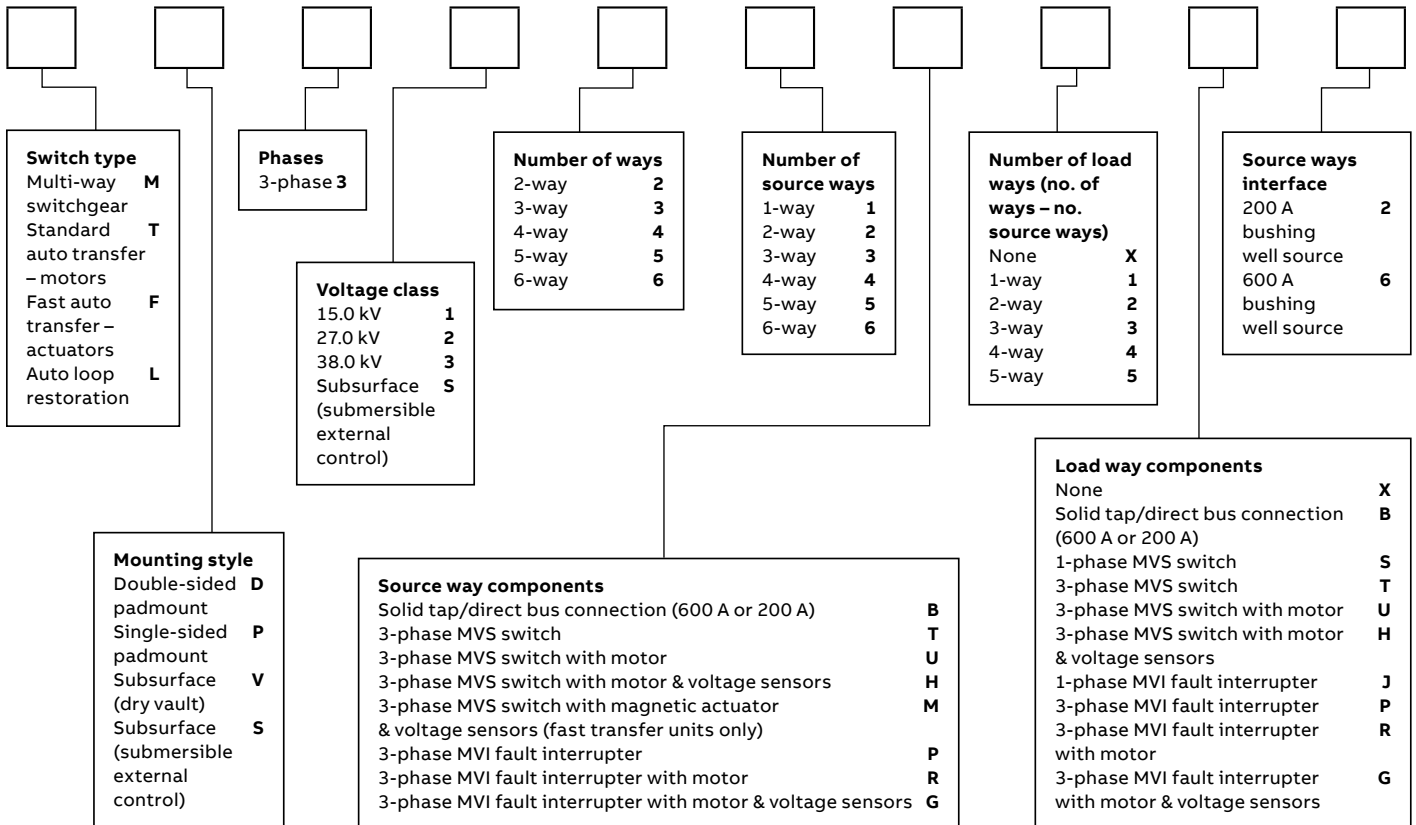

## Underground distribution switchgear

### Elastimold multi-way switchgear and transfer packages

**Example:** Auto transfer switchgear with Elastimold control package

**TD3242H2P62AFFXAE000:** Automatic transfer, double-sided padmount, 3-phase, 27.0 kV, 125 kV BIL, 12.5 kA interrupting capability, 4-ways, 2 source ways, source component: three-phase molded vacuum switches (MVS3) with 12–24 V DC motor and voltage sensors, 2 load ways, load component: three-phase molded vacuum interrupter (MVI3), 600 A bushing interfaces (source), 200 A bushing well interfaces (load), source control: Elastimold automatic transfer control, load control: Elastimold 80 control: TCCs select through E-set software, PT: two (2) 27 kV PT (13200–14400 V AC (WYE), enclosure: mild steel, Munsell green 7GY 3.29/1.5 and flat ground bar, English labels and instructions.

#### Online switchgear configurator

The ABB online switchgear configurator makes it easy to order Elastimold switchgear by walking you step by step through configuration. See pages A89–A90 for details.

Indicates field that must be filled in to complete order.

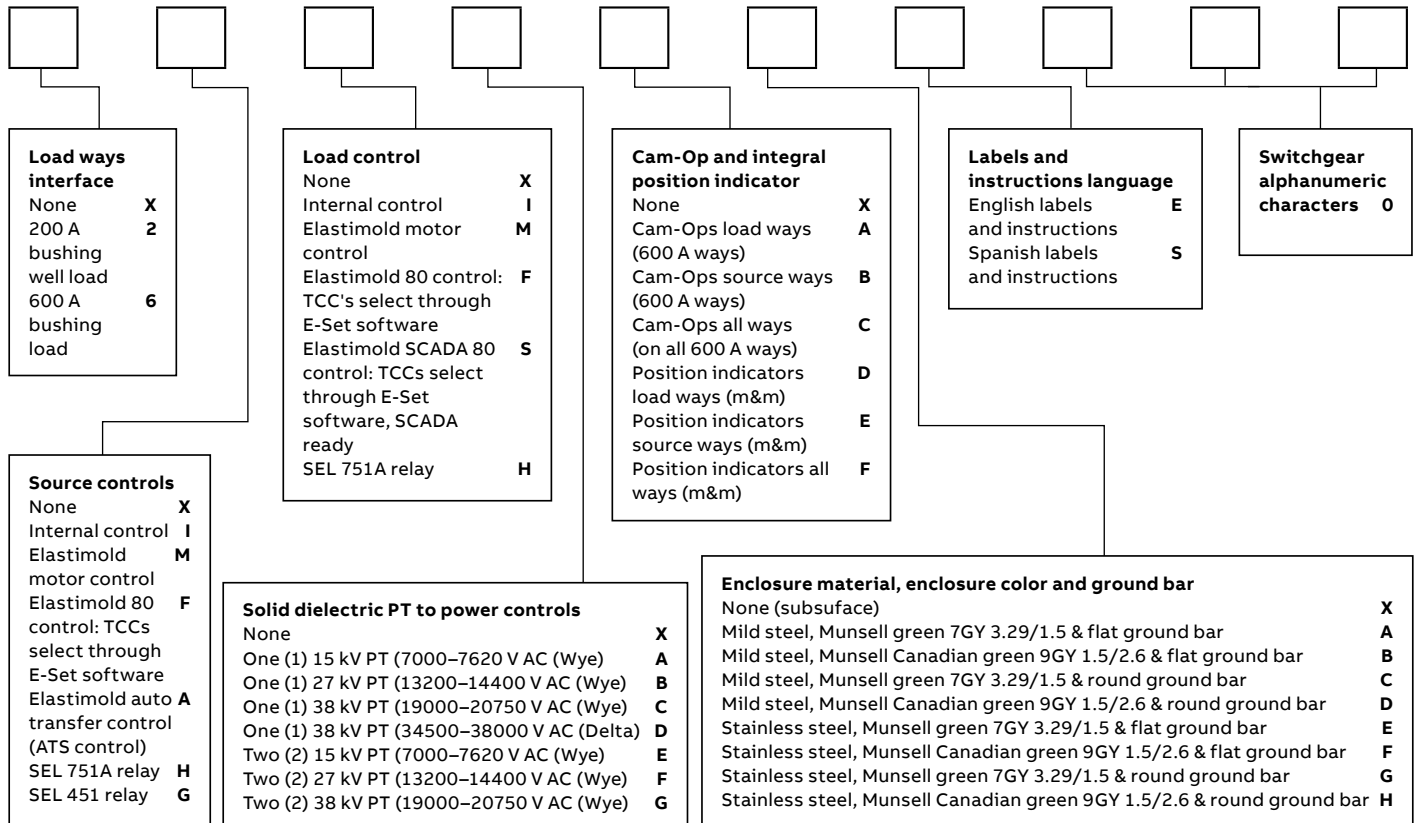



# Underground distribution switchgear

## Elastimold multi-way switchgear and transfer packages

### Elastimold switching and sectionalizing switchgear

Cat. no.	Description	Width in. (mm)	Height in. (mm)	Depth in. (mm)	Weight lb. (kg)	Diagram
<b>Vault</b>						
ESV313-TTT-XXX	15 kV 3-way 3-phase switch	48 (1,219)	36 (914)	22 (559)	750 (340)	
ESV323-TTT-XXX	27 kV 3-way 3-phase switch	48 (1,219)	36 (914)	22 (559)	750 (340)	
ESV333-TTT-XXX	38 kV 3-way 3-phase switch	48 (1,219)	36 (914)	22 (559)	750 (340)	
ESV314-TTTT-XXXX	15 kV 4-way 3-phase switch	48 (1,219)	36 (914)	22 (559)	880 (399)	
ESV324-TTTT-XXXX	27 kV 4-way 3-phase switch	48 (1,219)	36 (914)	22 (559)	880 (399)	
ESV334-TTTT-XXXX	38 kV 4-way 3-phase switch	48 (1,219)	36 (914)	22 (559)	880 (399)	
<b>Padmount</b>						
PMVS1-21-15-XX	15 kV 2-way 3-phase switch	36 (914)	30 (762)	30 (762)	310 (141)	
PMVS1-21-27-XX	27 kV 2-way 3-phase switch	36 (914)	30 (762)	30 (762)	310 (141)	
PMVS1-21-38-XX	38 kV 2-way 3-phase switch	36 (914)	30 (762)	30 (762)	310 (141)	
ESD312-T-XX	15 kV 2-way 3-phase switch	36 (914)	48 (1,219)	42 (1,067)	680 (308)	
ESD322-T-XX	27 kV 2-way 3-phase switch	36 (914)	48 (1,219)	42 (1,067)	680 (308)	
ESD332-T-XX	38 kV 2-way 3-phase switch	36 (914)	48 (1,219)	42 (1,067)	680 (308)	
ESD313-TTT-XXX	15 kV 3-way 3-phase switch	54 (1,317)	48 (1,219)	54 (1,317)	1,250 (567)	
ESD323-TTT-XXX	27 kV 3-way 3-phase switch	54 (1,317)	48 (1,219)	54 (1,317)	1,250 (567)	
ESD333-TTT-XXX	38 kV 3-way 3-phase switch	54 (1,317)	48 (1,219)	54 (1,317)	1,250 (567)	
ESD314-TTTT-XXXX	15 kV 4-way 3-phase switch	54 (1,317)	48 (1,219)	54 (1,317)	1,380 (626)	
ESD324-TTTT-XXXX	27 kV 4-way 3-phase switch	54 (1,317)	48 (1,219)	54 (1,317)	1,380 (626)	
ESD334-TTTT-XXXX	38 kV 4-way 3-phase switch	54 (1,317)	48 (1,219)	54 (1,317)	1,380 (626)	

Note: X = 6 for 600 A or 2 for 200 A.  
Other configurations are available. Consult your local representative for configurations not shown here.

### Diagrams

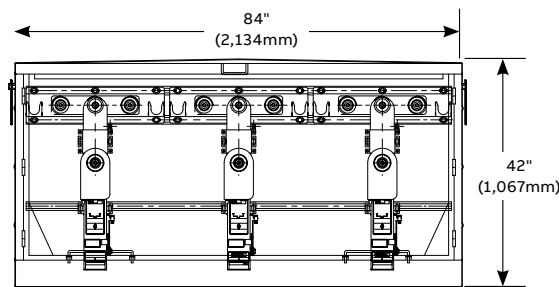

Single-side padmount ESP313-BJB-626

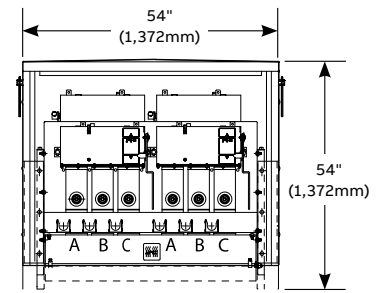

Double-side padmount ESD3X4-IIPP-6622-S

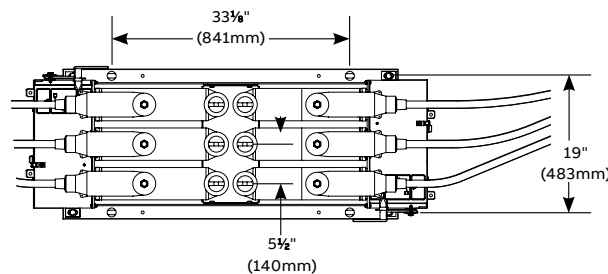

Subsurface ESS3X2-TT-66

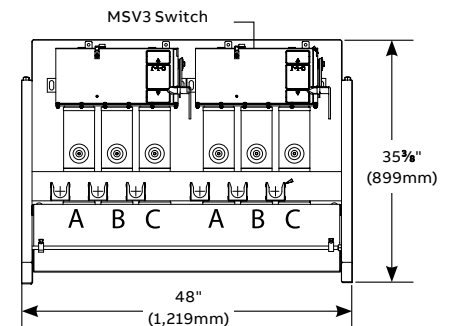

Vault ESV3X4-TTTT-2222

## Underground distribution switchgear

Elastimold multi-way switchgear and transfer packages

### Elastimold overcurrent protection switchgear

Cat. no.	Description	Width in. (mm)	Height in. (mm)	Depth in. (mm)	Weight lb. (kg)	Diagram
<b>Vault</b>						
ESV313-TPP-XXX	15 kV 3-way 3-phase (1) source switch, (2) vacuum interrupter taps	40 (1,016)	48 (1,219)	22 (559)	660 (299)	
ESV323-TPP-XXX	27 kV 3-way 3-phase (1) source switch, (2) vacuum interrupter taps	40 (1,016)	48 (1,219)	22 (559)	660 (299)	
ESV313-TTP-XXX	15 kV 3-way 3-phase (2) source switches, (1) vacuum interrupter tap	40 (1,016)	48 (1,219)	22 (559)	660 (299)	
ESV323-TTP-XXX	27 kV 3-way 3-phase (2) source switches, (1) vacuum interrupter tap	40 (1,016)	48 (1,219)	22 (559)	660 (299)	
ESV314-TPPP-XXXX	15 kV 4-way 3-phase (1) source switch, (3) vacuum interrupter taps	40 (1,016)	48 (1,219)	22 (559)	880 (399)	
ESV324-TPPP-XXXX	27 kV 4-way 3-phase (1) source switch, (3) vacuum interrupter taps	40 (1,016)	48 (1,219)	22 (559)	880 (399)	
ESV314-TTPP-XXXX	15 kV 4-way 3-phase (2) source switches, (2) vacuum interrupter taps	40 (1,016)	48 (1,219)	22 (559)	880 (399)	
ESV324-TTPP-XXXX	27 kV 4-way 3-phase (2) source switches, (2) vacuum interrupter taps	40 (1,016)	48 (1,219)	22 (559)	880 (399)	
ESV314-TTTP-XXXX	15 kV 4-way 3-phase (3) source switches, (1) vacuum interrupter tap	40 (1,016)	48 (1,219)	22 (559)	880 (399)	
ESV324-TTTP-XXXX	27 kV 4-way 3-phase (3) source switches, (1) vacuum interrupter tap	40 (1,016)	48 (1,219)	22 (559)	880 (399)	
<b>Padmount</b>						
PMVI1-21-15-XX	15 kV 2-way 1-phase interrupter	36 (914)	30 (762)	30 (762)	310 (141)	
PMVI1-21-27-XX	27 kV 2-way 1-phase interrupter	36 (914)	30 (762)	30 (762)	310 (141)	
PMVI1-21-38-XX	38 kV 2-way 1-phase interrupter	36 (914)	30 (762)	30 (762)	310 (141)	
PMVI1-21-15-XX-3YY	15 kV 2-way 3-phase interrupter 1-phase trip selectable ext. control	48 (1,219)	42 (1,067)	30 (762)	680 (308)	
PMVI1-21-27-XX-3YY	27 kV 2-way 3-phase interrupter 1-phase trip selectable ext. control	48 (1,219)	42 (1,067)	30 (762)	680 (308)	
PMVI1-21-38-XX-3YY	38 kV 2-way 3-phase interrupter 1-phase trip selectable ext. control	48 (1,219)	42 (1,067)	30 (762)	680 (308)	
ESD312-P-XX	15 kV 2-way 3-phase (1) vacuum interrupter tap	36 (914)	48 (1,219)	42 (1,067)	680 (308)	
ESD322-P-XX	27 kV 2-way 3-phase (1) vacuum interrupter tap	36 (914)	48 (1,219)	42 (1,067)	680 (308)	
ESD332-P-XX	38 kV 2-way 3-phase (1) vacuum interrupter tap	36 (914)	48 (1,219)	42 (1,067)	680 (308)	
ESD313-TPP-XXX	15 kV 3-way 3-phase (1) source switch, (2) vacuum interrupter taps	54 (1,372)	48 (1,219)	54 (1,372)	1,160 (526)	
ESD323-TPP-XXX	27 kV 3-way 3-phase (1) source switch, (2) vacuum interrupter taps	54 (1,372)	48 (1,219)	54 (1,372)	1,160 (526)	
ESD333-TPP-XXX	38 kV 3-way 3-phase (1) source switch, (2) vacuum interrupter taps	72 (1,829)	54 (1,372)	72 (1,829)	1,500 (680)	
ESD313-TTP-XXX	15 kV 3-way 3-phase (2) source switches, (1) vacuum interrupter tap	54 (1,372)	48 (1,219)	54 (1,372)	1,160 (526)	
ESD323-TTP-XXX	27 kV 3-way 3-phase (2) source switches, (1) vacuum interrupter tap	54 (1,372)	48 (1,219)	54 (1,372)	1,160 (526)	
ESD333-TTP-XXX	38 kV 3-way 3-phase (2) source switches, (1) vacuum interrupter tap	72 (1,829)	54 (1,372)	72 (1,829)	1,500 (680)	
ESD314-TPPP-XXXX	15 kV 4-way 3-phase (1) source switch, (3) vacuum interrupter taps	54 (1,372)	48 (1,219)	54 (1,372)	1,380 (626)	
ESD324-TPPP-XXXX	27 kV 4-way 3-phase (1) source switch, (3) vacuum interrupter taps	54 (1,372)	48 (1,219)	54 (1,372)	1,380 (626)	
ESD334-TPPP-XXXX	38 kV 4-way 3-phase (1) source switch, (3) vacuum interrupter taps	72 (1,829)	54 (1,372)	72 (1,829)	1,500 (680)	
ESD314-TTPP-XXXX	15 kV 4-way 3-phase (2) source switches, (2) vacuum interrupter taps	54 (1,372)	48 (1,219)	54 (1,372)	1,380 (626)	
ESD324-TTPP-XXXX	27 kV 4-way 3-phase (2) source switches, (2) vacuum interrupter taps	54 (1,372)	48 (1,219)	54 (1,372)	1,380 (626)	
ESD334-TTPP-XXXX	38 kV 4-way 3-phase (2) source switches, (2) vacuum interrupter taps	72 (1,829)	54 (1,372)	72 (1,829)	1,500 (680)	
ESD314-TTTP-XXXX	15 kV 4-way 3-phase (3) source switches, (1) vacuum interrupter tap	54 (1,372)	48 (1,219)	54 (1,372)	1,380 (626)	
ESD324-TTTP-XXXX	27 kV 4-way 3-phase (3) source switches, (1) vacuum interrupter tap	54 (1,372)	48 (1,219)	54 (1,372)	1,380 (626)	
ESD334-TTTP-XXXX	38 kV 4-way 3-phase (3) source switches, (1) vacuum interrupter tap	72 (1,829)	54 (1,372)	72 (1,829)	1,500 (680)	

Note: X = 6 for 600 A or 2 for 200 A.

YY = 10, 20, 30, 80 for different electronic controls. Consult your local representative on 38 kV multi-way configurations.

# Elastimold

## Fused loadbreak elbows

The fastest, most cost-effective way to improve a distribution system's reliability.

- Combined full-range current-limiting fusing 15/25 kV hotstick-operable, loadbreak elbow switching quickly improves the distribution system's reliability without the expense of adding a separate piece of switchgear or replacing existing sectionalizing cabinets
- Current-limiting fuses improve the fault close rating of the elbow (10 kA) to that of the fuse, thereby reducing the risk of component damage or personnel injury
- Neon voltage indicators (V2) attached to elbow test points to provide quick and convenient blown-fuse indication
- EPDM molded rubber deadfront construction enables elbows to be fully sealed and submersible, and they insulate, shield and eliminate exposed live parts
- Two-piece housing enables easy fuse replacement

Replace existing 200 A tap elbows with Elastimold fused elbows to protect light-duty underground distribution systems, including sub-loops, radial taps, junctions, transformers and other equipment.

Elastimold fused elbows provide full-range current-limiting fusing with 50 kA interrupting capability. They are rated for 5 kV ungrounded to 28 kV grounded Wye. Plus they provide 15/25 kV hotstick-operable, loadbreak elbow switching.



## Elastimold

### Fused loadbreak elbows

#### Ratings

System voltage class (kV)	15	25*	25/28*
Nominal fuse voltage (kV)	8.3	15.5	17.2
Rated maximum fuse voltage (kV)	8.8/10	15.5	17.2
Frequency (Hz)	50/60	50/60	50/60
BIL impulse withstand (kV)	95	125	140
One-minute AC withstand (kV)	34	40	45
Fifteen-minute DC withstand (kV)	53	78	78
Corona extinction (kV)	11	19	21.5
Symmetrical interrupting capability (A)	50,000	50,000	50,000
Current rating (A)	3-80	6-20	3-45

#### Application information

**Construction:** Submersible, non-venting, deadfront, corrosion resistant

**Ambient temperature range:** -30 °C to 65 °C

\* The 15.5 kV L-G rated fuse requires 75% grounded load to be applied on a 25 kV system. The 17.2 kV L-G rated fuse requires at least 75% grounded load to be applied on a 28 kV system.

Note: Fuses are only suitable for the system voltage class shown if the recovery voltage across the fuse will not exceed its rated maximum voltage. For three-phase applications, this generally requires that protected transformers be gndY-gndY and have at least 50% grounded load. Fuse replacement requires the elbow to be de-energized.

For applications with Delta connections or less than 50% grounded load, the fuse maximum voltage must be greater than system line to line voltage, which may require using the next larger system class housing and fuse.



#### Certified tests

Elastimold fused elbows have been designed and tested per applicable portions of IEEE, ANSI and other industry standards, including:

**ANSI C37.40** Standard for current-limiting fuse service conditions

**ANSI C37.41** Standard for current-limiting fuse design and testing

**ANSI C37.47** Standard for current-limiting fuse ratings and specifications

**IEEE 386** Standard for separable connectors

# Elastimold

## Fused loadbreak elbows

### Electrical characteristics of Elastimold EFX-E elbow fuses

System voltage class (kV)	Nominal fuse voltage rating (kV)	Current rating (amps)	Fuse cat. no. (N1)	Rated maximum voltage (kV)	Maximum continuous current (A) (N2) (N6) (N7)			Peak arc voltage (kV) (N5)	Minimum melt I <sup>2</sup> t (amp <sup>2</sup> -sec)	Maximum total I <sup>2</sup> t (amp <sup>2</sup> -sec) (N3) (N4)	Fuse housing
					25 °C	40 °C	65 °C				
15	8.3	3	EFX083003-E	10.0	4.3	4.2	3.9	30	100	350	168FLR1
			EFX083006-E		9.5	9.0	8.5	32	620	2,700	
			EFX083008-E		11.5	11.0	10.5	28	800	4,000	
			EFX083010-E		14.0	13.5	13.0	28	800	4,000	
			EFX083012-E		19.0	18.5	17.5	26	920	8,000	
			EFX083018-E		21.0	20.0	19.0	26	1,310	9,500	
			EFX083020-E		26.0	25.0	24.0	26	1,620	11,000	
			EFX083025-E		34.0	33.0	31.0	26	3,660	22,000	
			EFX083030-E		37.5	36.5	34.5	26	5,250	30,000	
			EFX083040-E		43.0	42.0	40.0	26	8,700	50,000	
			EFX083045-E		49.0	47.0	45.0	26	12,800	70,000	
								8.8	70.0	68.0	
					80.0	77.5	73.5	22	51,200	280,000	
25	15.5	6	EFX155006-E	15.5	8.5	8.0	7.7	52	620	3,000	274FLR1
			EFX155008-E		10.5	10.0	9.5	40	800	4,300	
			EFX155010-E		13.0	12.5	12.0	40	800	4,300	
			EFX155012-E		16.0	15.5	15.0	38	920	8,000	
			EFX155018-E		20.0	19.5	18.5	38	1,620	13,000	
			EFX155020-E		23.5	22.5	21.5	38	2,200	16,500	
25/28	17.2	3	EFX172003-E	17.2	4.3	4.2	3.9	51	100	510	274FLR3
			EFX172006-E		9.5	9.0	8.5	54	620	3,250	
			EFX172008-E		11.5	11.0	10.5	46	800	4,600	
			EFX172010-E		14.0	13.5	13.0	46	800	4,600	
			EFX172012-E		18.0	17.5	16.5	43	920	8,500	
			EFX172018-E		20.0	19.5	18.5	45	1,310	10,000	
			EFX172020-E		24.0	23.0	22.0	45	1,620	12,500	
			EFX172025-E		31.5	30.5	29.0	45	3,660	27,500	
			EFX172030-E		35.5	34.5	32.5	45	5,250	37,500	
			EFX172040-E		41.0	40.0	38.0	45	8,700	62,500	
					46.0	45.0	42.5	45	12,800	87,500	

#### Notes:

N1. Ratings have maximum interrupting capability of 50 kA, except 17.2 kV 3 A (EFX172003-E) which tested at 44 kA.

N2. Fuses have a rated maximum application temperature (RMAT) of 65 °C. RMAT is the maximum temperature of the air, in contact with the elbow housing, at which fuses have been shown to be suitable for use.

N3. Tabulated maximum total I<sup>2</sup>t values are for currents of 50,000 A at the nominal voltage of the fuse. Values for 8.3 kV fuses at 10 kV are approximately 30% higher. Values for 17.2 kV fuses at 15.5 kV are approximately 20% lower.

N4. Maximum total I<sup>2</sup>t values are reduced for currents below 50,000 A. For example, at 10,000 A, maximum total I<sup>2</sup>t values are approximately 15% less than the published values.

N5. Peak arc voltages listed are for 50,000 A currents at the rated maximum voltage listed. Reduced currents and voltages will reduce the peak arc voltage.

Consult the factory for further information.

N6. Maximum continuous currents at ambient temperatures other than those listed may be determined by derating the fuses by .2% per degree C over 25 °C.

For example: At 40 °C the derating would be 15 x .2 = 3%, making the maximum continuous current of a 17.2 kV, 25 A fuse 31.5 x .97 = 30.5 A.

N7. Time-current characteristic curves are published at 25 °C. Reduction in the long time melting current of the fuses (approximately one hour and longer) due to higher ambient temperatures is the same as described above for "Maximum continuous currents."

## Elastimold

### Fused loadbreak elbows

#### Recommended Elastimold EFX-E elbow fuse at 40 °C ambient temperature (single-phase transformer)

##### Recommended fuse current ratings (amps)

Fuse voltage	8.3 kV										15.5 kV (17.2 kV)					
	Transformer 1-phase voltage rating (kV) phase-to-ground															
	1-phase transformer kVA	2.4		4.16		4.8		7.2		7.62		12		14.4		16
A		B	A	B	A	B	A	B	A	B	A	B	A	B	A	B
10	–	6	–	6 <sup>a</sup>	–	3	–	3	–	3	–	6 <sup>a</sup>	–	6 <sup>a</sup>	–	(3 <sup>a</sup> )
15	–	10	–	6	–	6 <sup>a</sup>	–	3	–	3	–	6 <sup>a</sup>	–	6 <sup>a</sup>	–	(3 <sup>a</sup> )
25	12	20	–	8	–	8	–	6	–	6	–	6 <sup>a</sup>	–	6 <sup>a</sup>	–	(3)
37.5	20	25	–	12	–	12	–	8	–	6	–	6	–	6 <sup>a</sup>	–	(6 <sup>a</sup> )
50	25	40	18	20	12	20	10	12	–	10	–	6	–	6	–	(6 <sup>a</sup> )
75	45	65	20	30	20	25	12	20	12	18	–	10	–	8	–	(8)
100	65	80	30	45	25	40	18	25	18	25	12	18	10	12	–	(10)
167	–	–	65	80	45	65	25	45	25	45	18	(25)	18	20	(12)	(20)
250	–	–	80	–	80	–	45	65	45	65	(25)	(45)	20	(30)	(20)	(30)
333	–	–	–	–	–	–	65	–	80	–	(40)	–	(30)	(45)	(25)	(45)
500	–	–	–	–	–	–	–	–	–	–	–	–	(45)	–	(45)	–

#### Recommended Elastimold EFX-E elbow fuse at 40 °C ambient temperature (3-phase GNDY-GNDY transformers)

##### Recommended fuse current ratings (amps)

Fuse voltage	8.3 kV										15.5 kV (17.2 kV)							
	Transformer 3-phase voltage rating (kV), phase to phase																	
	3-phase GNDY-GNDY transformer kVA	2.4		4.16		4.8		7.2–7.96		8.32		12.47		13.2–14.4		20.8		22.9–24.9
A		B	A	B	A	B	A	B	A	B	A	B	A	B	A	B	A	B
15	–	6	–	3	–	3	–	3 <sup>a</sup>	–	3 <sup>a</sup>	–	6 <sup>a</sup>	–	6 <sup>a</sup>	–	6 <sup>a</sup>	–	(3 <sup>a</sup> )
22.5	–	8	–	6 <sup>a</sup>	–	6 <sup>a</sup>	–	3	–	3	–	6 <sup>a</sup>	–	6 <sup>a</sup>	–	6 <sup>a</sup>	–	(3 <sup>a</sup> )
30	10	12	–	6	–	6	–	6 <sup>a</sup>	–	3	–	6 <sup>a</sup>	–	6 <sup>a</sup>	–	6 <sup>a</sup>	–	(3 <sup>a</sup> )
45	12	20	–	10	–	8	–	6	–	6 <sup>a</sup>	–	6 <sup>a</sup>	–	6 <sup>a</sup>	–	6 <sup>a</sup>	–	(3 <sup>a</sup> )
75	20	30	12	20	–	12	–	8	–	8	–	6	–	6	–	6 <sup>a</sup>	–	(3)
100	30	45	18	25	18	20	–	12	–	10	–	8	–	8	–	6 <sup>a</sup>	–	(6 <sup>a</sup> )
112.5	40	65	20	25	18	25	–	12	–	12	–	8	–	8	–	6	–	(6 <sup>a</sup> )
150	45	80	25	40	20	30	18	20	12	20	10	12	10	12	–	6	–	(6)
200	65	80	40	65	30	45	20	25	18	25	12	18	12	18	8	10	–	(8)
225	80	–	45	65	40	65	20	30	20	25	12	20	12	18	8	10	–	(10)
300	–	–	65	80	45	80	30	45	25	40	18	25	18	25	12	18	–	(12)
500	–	–	–	–	80	–	65	80	45	80	30	45	30	45	18	(25)	(18)	(25)
750	–	–	–	–	–	–	80	–	80	–	45	65	45	–	(25)	(45)	(25)	(40)
1,000	–	–	–	–	–	–	–	–	–	–	80	–	–	–	(40)	–	(40)	–

##### Notes:

1. Column A = 140–200% of transformer rating and Column B = 200–300% of transformer rating.

2. Ratings in parentheses are 17.2 kV fuses.

3. 8.3 kV, 3–45 A fuses and 15.5 kV, 6–20 A fuses are used in the small (size 1) elbow housing; 8.3 kV, 65–80 A fuses and 17.2 kV, 3–45 A fuses are used in the large (size 3) elbow fuse housing.

4. Recommended fuses meet inrush criteria of 12 times transformer full-load current for .1 second and 25 times transformer full-load current for .01 second. Fuses also meet cold-load pickup criteria of 6 times transformer full-load current for 1 second and 3 times transformer full-load current for 10 seconds.

A. Fuse allows greater than 300% of transformer rating.

For applications with Delta connections or less than 50% grounded load, the fuse maximum voltage must be greater than system line to line voltage, which may require using the next larger system class housing and fuse.

# Elastimold

## Fuse housings

The following diagram shows how to construct a catalog number for fuse housings.

Indicates field that must be filled in to complete order.

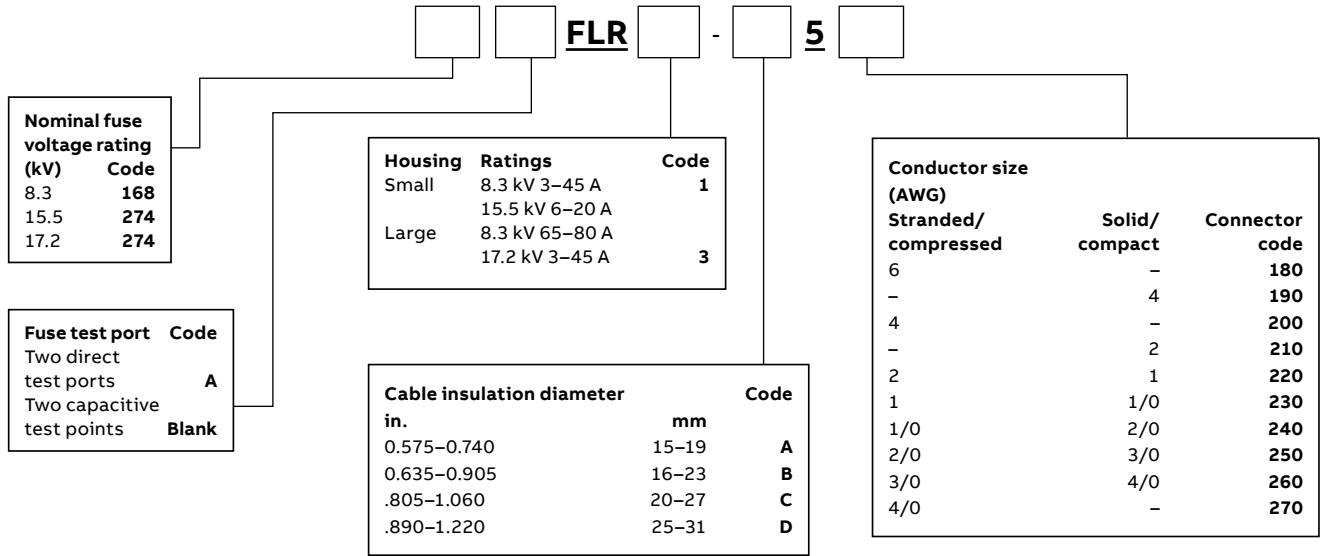

168FLR1

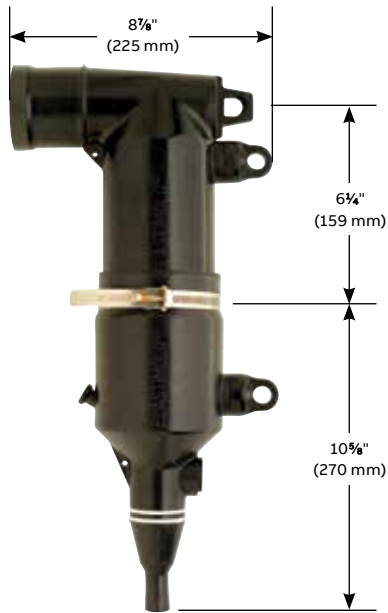

274FLR1

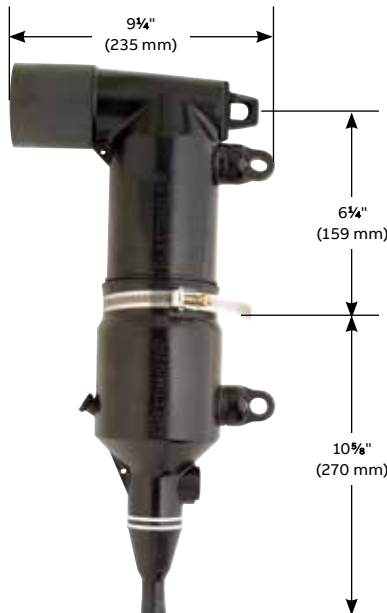

168FLR3 A = 8 7/8" (225 mm)  
274FLR3 A = 9 1/4" (235 mm)

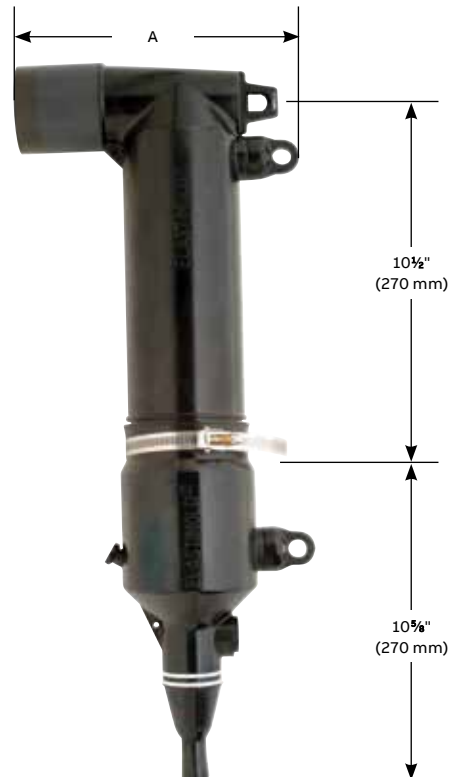

- Notes:
1. All dimensions rounded up to the nearest eighth inch.
  2. Also available with direct test port.
  3. Dimensions with direct test port units are 10 1/4" (260 mm) or 10 5/8" (270 mm).
  4. 168FLR3 uses a large housing with a 15 kV, 200 A elbow interface.

# Elastimold

## Full-range current-limiting fuses

The following diagram shows how to construct a catalog number for full-range current-limiting fuses.

Indicates field that must be filled in to complete order.

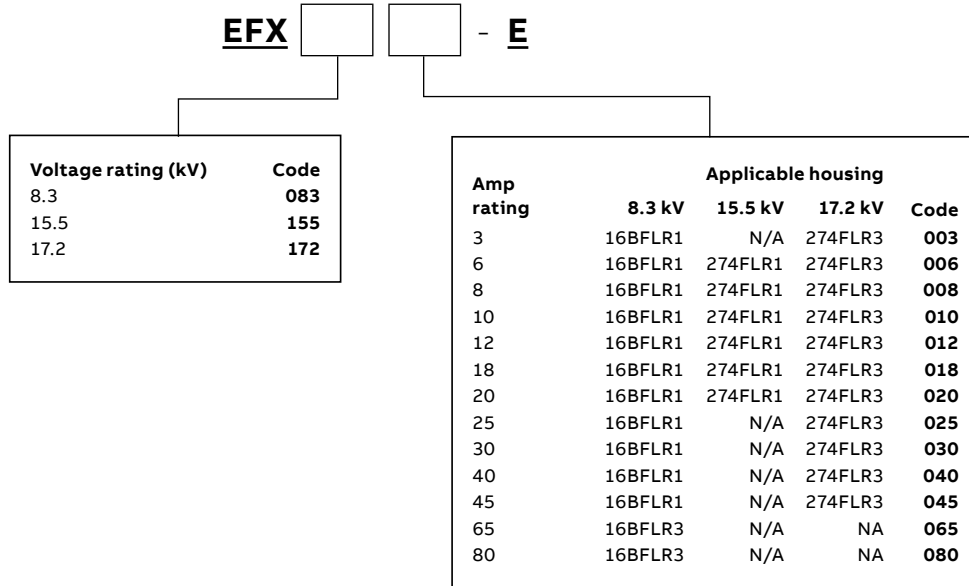

8.3 kV (3–45 A)/15.5 kV (6–20 A) fuse

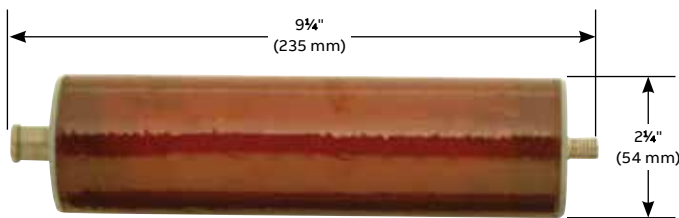

8.3 kV (65–80 A)/17.2 kV (3–45 A) fuse

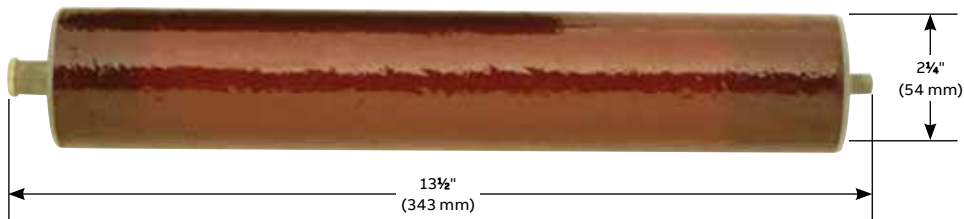

Note: All dimensions rounded up to the nearest eighth inch.



## Elastimold

### Molded current-limiting fuses (MCLF)

You're covered. These fuses provide full-range protection through 50 kA interrupting current.

#### Molded current-limiting fuses

Molded current-limiting fuses feature modular construction with a center replaceable fuse section and interchangeable end fittings for elbow connection or direct attachment to equipment-mounted bushings. The various end fittings enable fuses to be applied throughout the system, including switchgear, junctions, transformers, cable runs and taps.

- EPDM molded rubber deadfront construction insulates, shields and eliminates exposed live parts
- Lightweight fuses are fully sealed and submersible
- Specially designed fuse elements with built-in low- and high-current interrupting capability provide full-range fault current protection through 50 kA
- Current-limiting protection limits the system available fault current and dramatically reduces stresses on equipment

- Internal fuse shield prevents corona and deterioration of the fuse element
- Modular construction with a center replaceable fuse section and interchangeable end fittings enables elbow connection or direct attachment to equipment-mounted bushings on junctions, transformers, cable runs and taps
- Compact – suitable for padmount, subsurface or vault installations
- 304 stainless steel brackets and hold-down straps available accommodate a wide variety of mounting arrangements

#### Elastimold molded current-limiting fuses are available in:

- 80 A through 180 A ratings for applications on 5 kV systems
- 6 A through 115 A ratings for applications on 15 kV grounded Wye systems
- 6 A through 100 A ratings for applications on 25 kV grounded Wye systems
- 6 A through 50 A ratings for applications on 35 kV grounded Wye systems



## Elastimold

### Molded current-limiting fuses (MCLF)

#### Ratings

System voltage class (kV)	5	15	25/28*	35
Rated maximum fuse voltage (kV)	5.5	8.3/10**	15.5/17.2**	23
Frequency (Hz)	50/60	50/60	50/60	50/60
BIL impulse withstand (kV)	60	95	125/140	150
One-minute AC withstand (kV)	34	34	40-45	50
Fifteen-minute DC withstand (kV)	53	53	78	103
Corona extinction (kV)	11	11	19/21.5	26
Symmetrical interrupting capability (amp)	50,000	50,000	50,000	50,000
Current rating (amp)	80-180	10-115	10-100	10-50

#### Application information

Construction:	Submersible, non-venting, deadfront, corrosion resistant
Ambient temperature range:	-30 °C to 65 °C for 6-50 A fuses; -30 °C to 40 °C for > 50 A fuses.

\* 15.5 kV L-G rated fuses require 75% grounded load to be applied on a 25 kV system.

\*\* 17.2 kV L-G rated fuses require at least 75% grounded load to be applied on a 28 kV system.

Notes: Fuse replacement requires the MCLF to be de-energized. Fuses are only suitable for the system voltage class shown if the recovery voltage across the fuse will not exceed its rated maximum voltage. For three-phase applications, this generally requires that protected transformers be GNDY-GNDY and have at least 50% grounded load.

For applications with Delta connections or less than 50% grounded load, the fuse maximum voltage must be greater than system line to line voltage, which may require using the next larger system class housing and fuse.

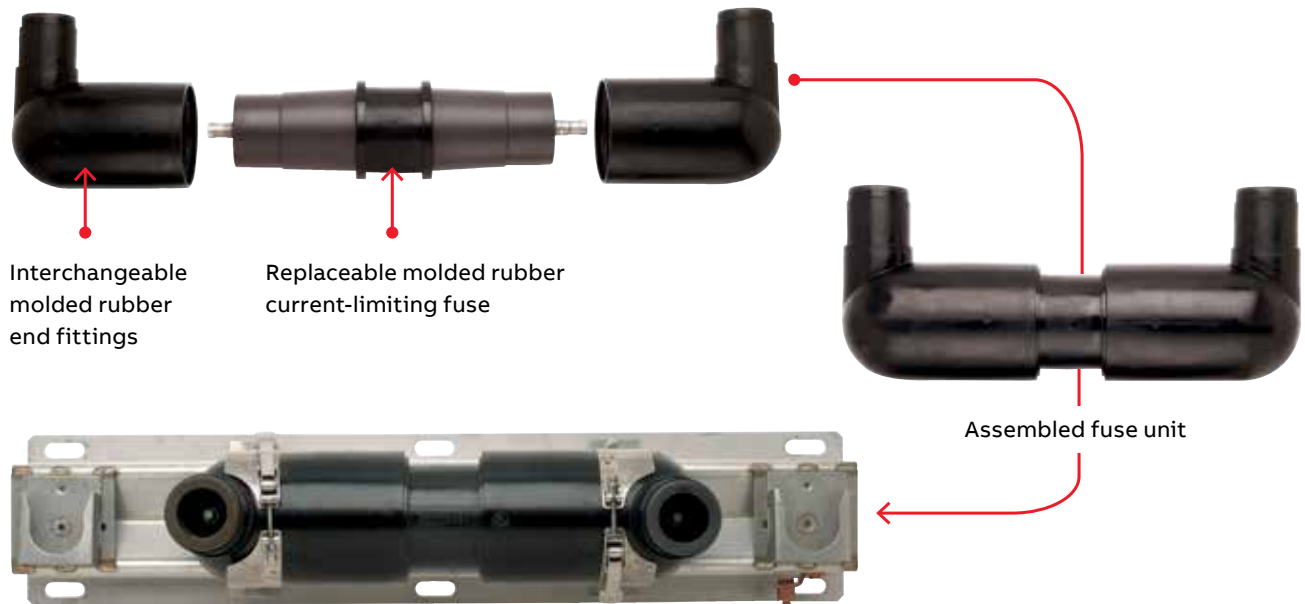

Assembled fuse unit with optional wall-mounting bracket

#### Certified tests

Elastimold molded current-limiting fuses have been designed and tested per applicable portions of IEEE, ANSI, NEMA and other industry standards, including:

**ANSI C37.40** Standard for current-limiting fuse service conditions

**ANSI C37.41** Standard for current-limiting fuse design and testing

**ANSI C37.47** Standard for current-limiting fuse ratings and specifications

**ANSI/IEEE 386** Standard for separable connectors and bushing interfaces

## Elastimold

### Molded current-limiting fuses (MCLF)

#### Electrical characteristics of encapsulated fuses used in MCLF

System voltage Class (kV)	Nominal fuse voltage rating (kV)	Current rating (amps)	Fuse cat. no. (N1)	Rated maximum voltage (kV)	Maximum continuous current (A) (N2) (N6)		Peak arc voltage (kV) (N5)	Minimum melt I <sup>2</sup> t (amp <sup>2</sup> -sec)	Maximum total I <sup>2</sup> t (amp <sup>2</sup> -sec) (N3) (N4)
					25 °C	40 °C			
5	5.5	80	M05CLF080	5.5	86	84	15	22,100	110,000
		100	M05CLF100		108	105	15	56,700	280,000
		125	M05CLF125		137	133	15	109,200	530,000
		150	M05CLF150		159	154	15	176,000	860,000
		180	M05CLF180		185	180	15	259,000	1,270,000
15	8.3	10	M15CLF010	10.0	14	13	28	800	4,000
		20	M15CLF020		23	22	26	1,620	11,000
		30	M15CLF030		35	33	26	5,250	30,000
		40	M15CLF040		43	41	26	8,700	50,000
		50	M15CLF050		51	47	26	12,800	70,000
		65	M15CLF065	8.3	73	71	25	25,200	100,000
		80	M15CLF080		87	84	25	47,000	185,000
		100	M15CLF100		106	103	25	78,300	330,000
		115	M15CLF115		120	116	25	115,150	480,000
25/28	15.5	10	M25CLF010	17.2	14	13	46	800	3,700
		20	M25CLF020		23	22	45	1,620	10,000
		30	M25CLF030		35	33	45	5,250	30,000
		40	M25CLF040		43	41	45	8,700	50,000
		50	M25CLF050		47	45	45	12,800	70,000
		65	M25CLF065	15.5	68	66	40	25,200	110,000
		80	M25CLF080		88	84	40	54,400	255,000
		100	M25CLF100		100	97	40	80,000	380,000
35	23.0	10	M35CLF010	23.0	14	13	61	800	4,800
		20	M35CLF020		23	22	60	1,620	13,000
		30	M35CLF030		35	33	60	5,250	38,000
		40	M35CLF040		41	40	60	8,700	61,000
		50	M35CLF050		47	46	60	12,800	82,000

#### Notes:

N1. Designs have a 50,000 A RMS symmetrical rating.

N2. 10–50 A fuses have a rated maximum application temperature of 65 °C, and 65–180 A fuses have a rated maximum application temperature of 40 °C. (RMAT is the maximum temperature of the air in contact with the MCLF housing at which the fuses have been shown suitable for use.)

N3. Tabulated maximum total I<sup>2</sup>t values are for currents of 50,000 A at the nominal voltage of the fuse. Fuses that have a rated maximum voltage higher than their nominal voltage rating will have a higher I<sup>2</sup>t let-through when applied at voltages up to these higher values. For example, maximum total I<sup>2</sup>t values are increased by approximately 30% when 8.3 kV fuses are applied at 10 kV and approximately 25% when 15.5 kV fuses are used at 17.2 kV.

N4. Maximum total I<sup>2</sup>t values are reduced for currents below 50,000 A. For example, at 10,000 A, I<sup>2</sup>t values are approximately 15% less than the published values.

N5. Peak arc voltages quoted are for 50,000 A currents at the rated maximum voltage listed. Reduced currents and voltages will reduce the peak arc voltage.

Consult the factory for further information.

N6. Maximum continuous currents at higher ambient temperatures may be determined by derating the fuses by .2% per degree C over 25 °C.

For example: At 40 °C, the derating would be 15 x .2 = 3%, making the maximum continuous current of a 20 A fuse 23.0 x .97 = 22 A.

## Elastimold

### Molded current-limiting fuses (MCLF)

#### Recommended MCLF at 40 °C ambient temperature (single-phase transformer)

Recommended fuse current ratings (amps)																			
Fuse voltage		(5.5 kV) 8.3 kV										15.5 kV				23 kV			
1-phase transformer kVA		Transformer 1-phase voltage rating (kV) phase-to-ground																	
		2.4		4.16		4.8		7.2		7.62		12		14.4		16		19.9	
		A	B	A	B	A	B	A	B	A	B	A	B	A	B	A	B	A	B
10		-	10 <sup>a</sup>	-	10 <sup>a</sup>	-	10 <sup>a</sup>	-	10 <sup>a</sup>	-	10 <sup>a</sup>	-	10 <sup>a</sup>	-	10 <sup>a</sup>	-	10 <sup>a</sup>	-	10 <sup>a</sup>
15		-	10	-	10 <sup>a</sup>	-	10 <sup>a</sup>	-	10 <sup>a</sup>	-	10 <sup>a</sup>	-	10 <sup>a</sup>	-	10 <sup>a</sup>	-	10 <sup>a</sup>	-	10 <sup>a</sup>
25		-	20	-	10	-	10	-	10 <sup>a</sup>	-	10 <sup>a</sup>	-	10 <sup>a</sup>	-	10 <sup>a</sup>	-	10 <sup>a</sup>	-	10 <sup>a</sup>
37.5		20	30	-	20	-	20	-	10	-	10	-	10 <sup>a</sup>	-	10 <sup>a</sup>	-	10 <sup>a</sup>	-	10 <sup>a</sup>
50		30	40	20	30	-	20	-	10	-	10	-	10 <sup>a</sup>	-	10 <sup>a</sup>	-	10 <sup>a</sup>	-	10 <sup>a</sup>
75		50	65	30	40	20	30	-	20	-	20	-	10	-	10	-	10	-	10 <sup>a</sup>
100		65	(80)	40	50	30	50	20	30	20	30	-	20	-	10	-	10	-	10
167		(100)	(150)	65	(80)	50	65	30	50	30	50	20	30	20	30	-	20	-	20
250		(150)	-	(100)	(125)	(80)	(100)	50	65	50	65	30	50	30	40	20	30	20	30
333		(180)	-	(125)	(180)	(100)	(150)	65	100	65	100	50	65	30	50	30	50	20	40
500		-	-	(180)	-	(150)	-	115	-	115	-	65	100	65	80	50	-	40	-
750		-	-	-	-	-	-	-	-	-	-	100	-	80	100	-	-	-	-
1,000		-	-	-	-	-	-	-	-	-	-	-	-	100	-	-	-	-	-

#### Recommended MCLF at 40 °C ambient temperature (3-phase transformer GNDY-GNDY)

Recommended fuse current ratings (amps)																					
Fuse voltage		(5.5 kV) 8.3 kV										15.5 kV				23 kV					
3-phase GNDY-GNDY transformer kVA		Transformer 3-phase voltage rating (kV), phase to phase																			
		2.4		4.16		4.8		7.2-7.96		8.32		12.47		13.2-14.4		20.8		22.9-24.9		34.5	
		A	B	A	B	A	B	A	B	A	B	A	B	A	B	A	B	A	B	A	B
15		-	10 <sup>a</sup>	-	10 <sup>a</sup>	-	10 <sup>a</sup>	-	10 <sup>a</sup>	-	10 <sup>a</sup>	-	10 <sup>a</sup>	-	10 <sup>a</sup>	-	10 <sup>a</sup>	-	10 <sup>a</sup>	-	10 <sup>a</sup>
22.5		-	10	-	10 <sup>a</sup>	-	10 <sup>a</sup>	-	10 <sup>a</sup>	-	10 <sup>a</sup>	-	10 <sup>a</sup>	-	10 <sup>a</sup>	-	10 <sup>a</sup>	-	10 <sup>a</sup>	-	10 <sup>a</sup>
30		-	10	-	10 <sup>a</sup>	-	10 <sup>a</sup>	-	10 <sup>a</sup>	-	10 <sup>a</sup>	-	10 <sup>a</sup>	-	10 <sup>a</sup>	-	10 <sup>a</sup>	-	10 <sup>a</sup>	-	10 <sup>a</sup>
45		-	20	-	10	-	10	-	10 <sup>a</sup>	-	10 <sup>a</sup>	-	10 <sup>a</sup>	-	10 <sup>a</sup>	-	10 <sup>a</sup>	-	10 <sup>a</sup>	-	10 <sup>a</sup>
75		30	40	-	20	-	20	-	10	-	10	-	10 <sup>a</sup>	-	10 <sup>a</sup>	-	10 <sup>a</sup>	-	10 <sup>a</sup>	-	10 <sup>a</sup>
100		40	50	20	30	20	30	-	20	-	10	-	10	-	10	-	10 <sup>a</sup>	-	10 <sup>a</sup>	-	10 <sup>a</sup>
112.5		40	65	20	30	20	30	-	20	-	20	-	10	-	10	-	10 <sup>a</sup>	-	10 <sup>a</sup>	-	10 <sup>a</sup>
150		50	(80)	30	50	30	40	20	30	-	20	-	10	-	10	-	10 <sup>a</sup>	-	10 <sup>a</sup>	-	10 <sup>a</sup>
200		65	(100)	40	65	40	50	20	30	20	30	-	20	-	20	-	10	-	10	-	10 <sup>a</sup>
225		(80)	(125)	50	65	40	65	30	40	30	50	-	20	-	20	-	10	-	10	-	10 <sup>a</sup>
300		(100)	(150)	65	(100)	65	(80)	40	50	30	50	20	30	20	30	-	20	10	20	-	10
500		(180)	-	(100)	(150)	(100)	(125)	65	(80)	50	80	30	50	30	50	20	30	20	30	-	20
750		-	-	(180)	-	(125)	(180)	(80)	(125)	80	115	50	80	50	65	30	50	30	40	20	30
1,000		-	-	-	-	(180)	-	(125)	(180)	115	-	65	100	65	100	50	65	40	65	30	40
1,500		-	-	-	-	-	-	(180)	-	-	-	100	-	100	-	65	100	65	80	40	-
2,000		-	-	-	-	-	-	-	-	-	-	-	-	-	-	100	-	80	-	50	-

#### Notes:

1. Column A = 140–200% of transformer rating and Column B = 200–300% of transformer rating.

2. Ratings in parentheses are 5.5 kV fuses.

3. Recommended fuses meet inrush criteria of 12 times transformer full-load current for .1 second and 25 times transformer full-load current for .01 second. Fuses also meet cold-load pickup criteria of 6 times transformer full-load current for 1 second and 3 times transformer full-load current for 10 seconds.

A. Fuse allows greater than 300% of transformer rating.

For applications with Delta connections or less than 50% grounded load, the fuse maximum voltage must be greater than system line to line voltage, which may require using the next larger system class housing and fuse.

# Elastimold

## Molded current-limiting fuses (MCLF)

**Model 22**

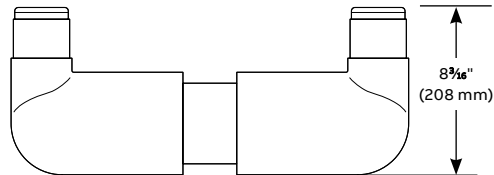
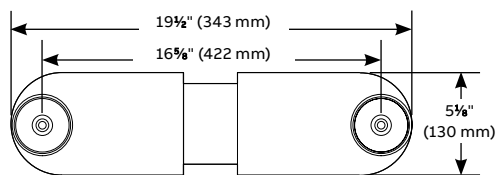

Approx. weight 30 lb. (13.6 kg)

**Model 222**

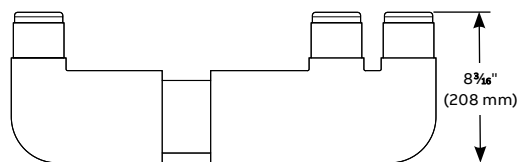
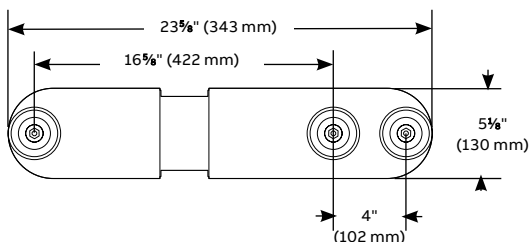

Approx. weight 35 lb. (15.9 kg)

**Model 2222**

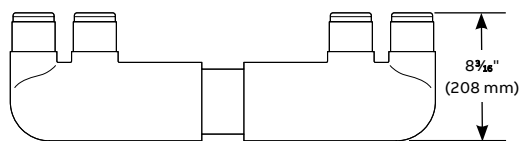
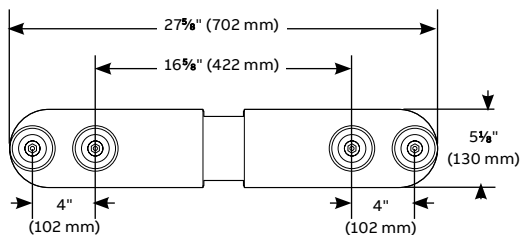

Approx. weight 40 lb. (18.1 kg)

**Model 66**

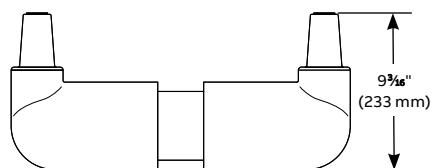
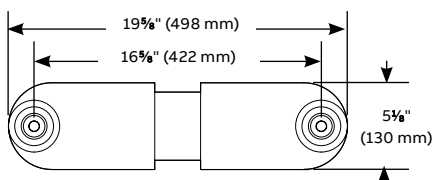

Approx. weight 40 lb. (18.1 kg)

**Model 6E2**

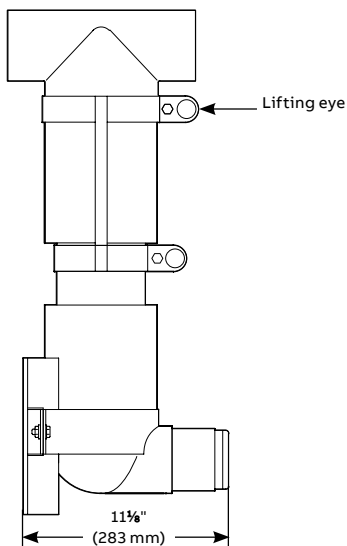

9/16" (14 mm) x 1" (25 mm) mounting slots on 5 1/2" (140 mm) centers

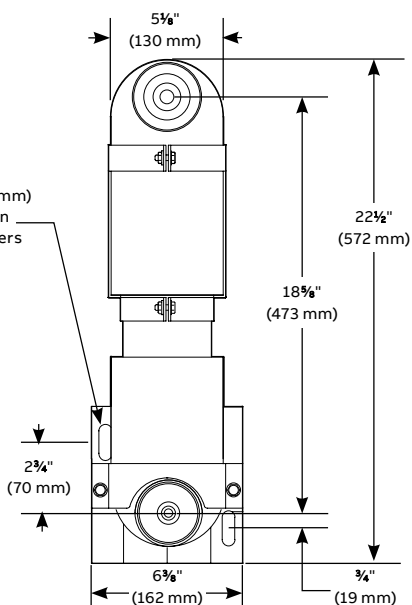

Approx. weight 30 lb. (13.6 kg)

# Elastimold

## Molded current-limiting fuses (MCLF)

### Model 6E6

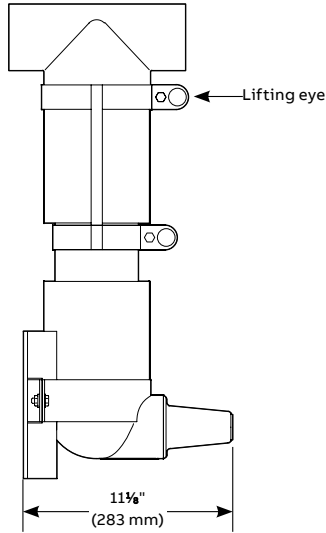

Note: Other models are available such as 26.

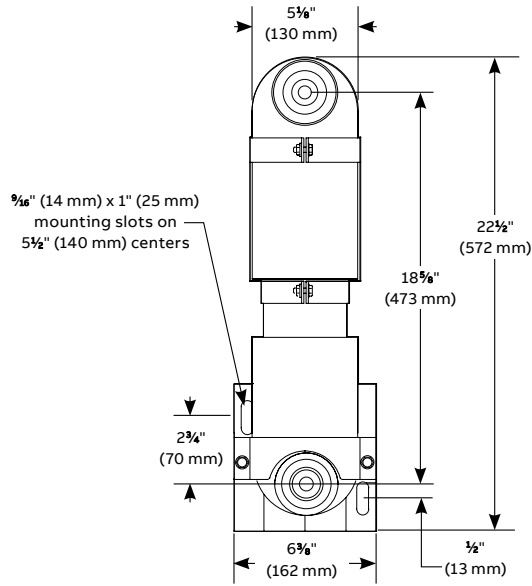

Approx. weight  
30 lb. (13.6 kg)

The following diagram shows how to construct a catalog number for a molded current-limiting fuse:

Indicates field that must be filled in to complete order.

**M**  **CLF**  -

Voltage class (kV)	Code
5.0	05
15.0	15
25.0	25
35.0	35

See page A14 for additional information.

Amps				
Voltage class				Amp code
5 kV	15 kV	25 kV	35 kV	
-	10	10	10	010
-	20	20	20	020
-	30	30	30	030
-	40	40	40	040
-	50	50	50	050
-	65	65	-	065
80	80	80	-	080
100	100	100	-	100
-	115	-	-	115
125	-	-	-	125
150	-	-	-	150
185	-	-	-	185

See page A17 for additional information.

Bushings	Bushing code
200 A bushing wells both ends	22
200 A bushing well on one end and two 200 A bushing wells on the other end	222
Two 200 A bushing wells on both ends	2222
600 A bushings on both ends	66
600 A elbow connector on one end and 200 A bushing well on the other end (not available for 35 kV)	6E2
600 A elbow connector on one end and 600 A bushing on the other end (not available for 35 kV)	6E6

See outline drawings preceding this chart for additional details.

Optional mounting brackets/accessories	Bracket code
Wall mounting bracket with parking stands and bolted style hold down straps (HDS)	WMB
Wall mounting bracket with parking stands and quick release style hold down straps (QRS)	WMBQ
Tilt mounting adapter; requires either WMB or WMBQ to enable up to 60° angle	TMA
Support mounting bracket for use with models 6E2 or 6E6 end-fitting arrangements; includes bolted-style hold-down strap	SMB
Bolted-style hold-down strap (qty: 1 required per end fitting)	HDS
Quick-release style hold-down strap (qty: 1 required per end fitting)	QRS

\*Options maybe purchased separately

# Elastimold

## Molded current-limiting fuses (MCLF)

### Mounting options

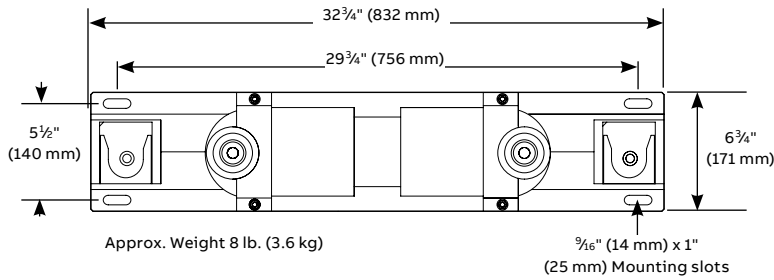

Optional WMB mounting bracket with adjustable parking stands for vertical mounting and fuse hold-down strips

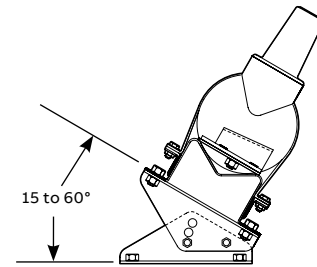

Optional – TMA universal tilt mounting

### Optimal end fittings

Cat. no.	Description	System voltage class (kV)	IEEE 386-1995 interface reference
EF2	200 A bushing well end fitting	5, 15, 25	Figure 3
EF22	Double 200 A bushing well end fitting	5, 15, 25	Figure 3
EF6	600 A bushing end fitting	5, 15, 25	Figures 11 and 13
EF6E	600 A elbow connector end fitting	5, 15, 25	Figure 11

Note: EF6E is equipped with a standard through-hole spade lug (Type O3700). Use this table only if end fittings are to be ordered and shipped separately from the fuse. See pages A98-A99 for assembled units.

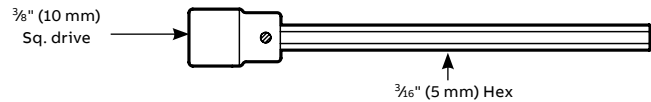

### Other options

Cat. no.	Description
MCLF-ADT	Hex wrench for set screw removal and replacement when disassembling end fittings. Supplied as standard with replacement fuses.

# Shielded surge arresters

## Metal oxide varistor (MOV) surge arresters

Fully shielded, fully submersible for convenient energized connection with 200 A loadbreak or deadbreak components up to 35 kV.

- IEEE 386 interfaces provide convenient energized connection with other 200 A loadbreak or deadbreak components
- EPDM molded rubber construction – Fully shielded and fully submersible for a variety of applications
- Compact size enables installation in your existing cabinetry, saving you money
- Three styles of arresters available fit your application and are easy to install
- Direct connection on PSA and BSA versions eliminates the need for additional accessories, saving even more money
- #4 AWG ground lead tethered to the jacket withstands 10,000 A for 10 cycles without fusing
- Ground lead also controls end plug when ejected, preventing uncontrolled trajectory, and maintains the housing shield ground connection after failure

Voltage surges that exceed the BIL rating of the distribution system components will cause damage to the installed equipment. To protect against these surges, overhead surge arresters are widely used. Their application is understood since overhead lines and equipment are directly affected by voltage surges (e.g. lightning). However, the use of overhead arresters alone will not guarantee proper protection of the insulation in the underground portion of an electrical distribution system. The let-through surge from the riser pole arresters into the underground systems could be enough to cause damage to the aging equipment insulation.

Elastimold MOV surge arresters provide high voltage lightning and switching surge protection of transformers, cable, equipment and other components typically located on underground power distribution systems. Proper placement, voltage selection and coordination with riser pole arresters minimize damaging surge voltages by improving protective margins.

Typical applications include installing an arrester at the end of a radial system or at both ends of an open point on a loop system. Additional arresters can be added at strategic locations upstream from the end point for optimum protection.

Metal oxide varistor (MOV) surge arresters are available in three styles: elbow (ESA™), parking stand (PSA™) and bushing (BSA™). The PSA and BSA arresters permit direct connection, eliminating the need for additional accessories. ESA elbow arresters are also available with a 200 A deadbreak interface for mating with other deadbreak accessories.

The following page highlights the different installation options using bushing and parking stand arresters where elbow arresters are normally used. Using BSAs and PSAs will contribute to saving space inside transformers and improving operability.

### Ratings

High current, short duration	All MOV arresters withstand two discharges of 40 kA crest
Low current, long duration	All MOV arresters withstand 20 surges of 75 A/2,000 microseconds duration
Duty cycle test	All MOV arresters withstand 22 operations of 5 kA crest at 8 x 20 microseconds duration while energized at rated voltage for the initial 20 operations and at maximum continuous operating voltage (MCOV) for the final two operations

Following each of the preceding tests, MOV arresters demonstrate thermal recovery at MCOV.



Installation options

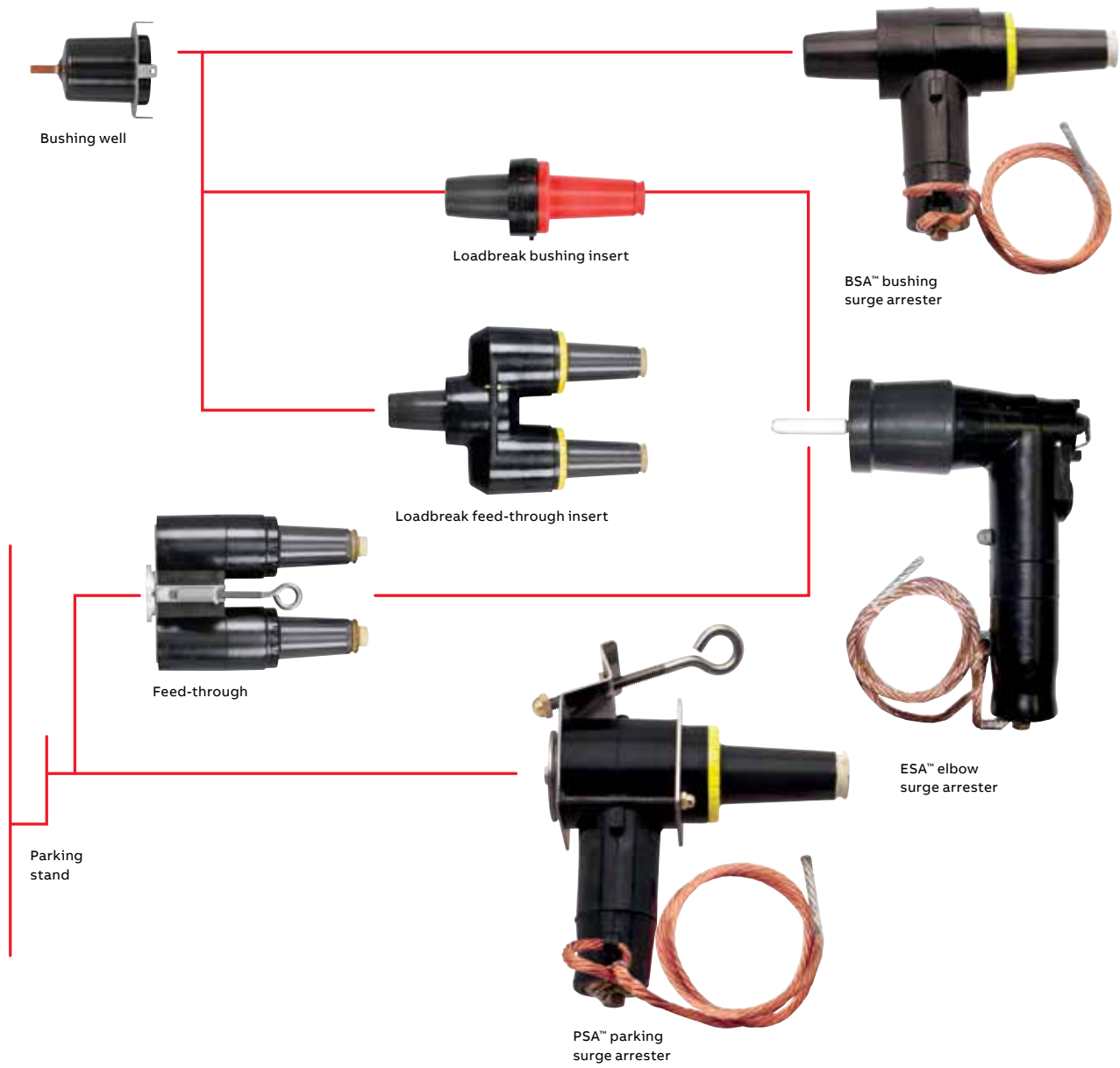

## Shielded surge arresters

Loop-feed circuit (type 2 transformer)



**Two elbow arresters and a feed-through**  
This approach uses elbow arresters only. (One of the elbow arresters may be mounted on the H1A bushing if operating procedures permit.)



**Elbow arrester and parking stand arrester**  
This approach can reduce overcrowding by eliminating the feed-through device. This is desirable in a mini-pad transformer.

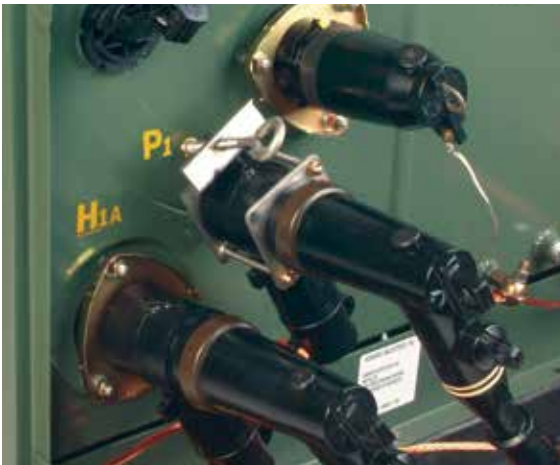

**Bushing arrester and parking stand arrester\***  
This approach is best for increasing operability and reducing transformer overcrowding.

The bushing arrester enables the source cable to be positioned on H1A, which conforms with some operating practices.

A bushing arrester mounted on H1A can be directed downward without interference. Potential interference between an elbow arrester on H1B and a cable parked on P is eliminated.

The bushing arrester requires significantly less space than an elbow arrester used with a feed-through insert.

Operability is enhanced because the open point can be closed by moving the parked cable to H1B without removing an arrester.

\* Transformers must be specified with bushing wells.

---

## Shielded surge arresters

Loop-feed circuit (type 2 transformer)

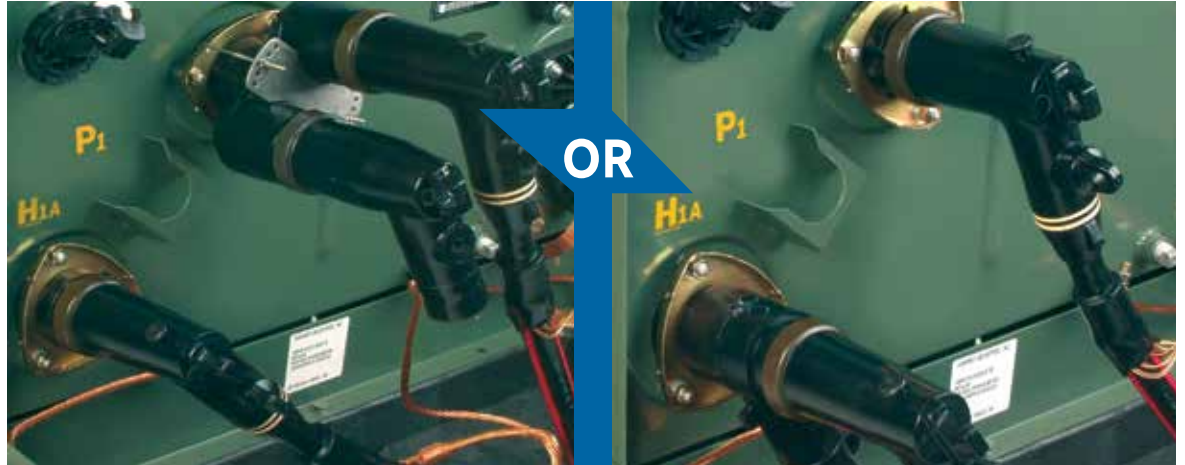

### Additional margin of protection

An additional margin of protection may be gained by adding an arrester at the next transformer upstream on each side of the open point. This application is dependent on the system voltage and condition of the cable.

If an additional arrester is added in the circuit, it can be an elbow arrester in combination with a feed-through insert or it can be a bushing arrester. Use of a bushing arrester will reduce transformer faceplate overcrowding.

### Other configurations

Other configurations are possible, such as specifying a bushing arrester on every transformer. This enables the open point to be quickly and easily moved to any point in the circuit while maintaining the surge protection (without moving all of the portable surge arresters).

The externally mounted bushing arrester provides the surge protection benefits without the negative factors of an under-oil arrester.

---

## Shielded surge arresters

Radial-feed circuit (end point)



### Single-bushing transformer

To add surge protection to a single-bushing transformer, use a bushing arrester or an elbow arrester with a feed-through insert.



### Two-bushing transformer

To add surge protection to a two-bushing transformer at the end point of a radial-feed circuit, add an elbow arrester to the unoccupied bushing or use a bushing arrester.

## Shielded surge arresters

Radial-feed circuit (end point)



### Conversion of a radial-feed transformer to a loop-feed, open-point transformer

To convert a single-bushing transformer to a loop-feed, open-point transformer, add a parking stand arrester and an elbow arrester in combination with a feed-through insert.

### Protective characteristics

Voltage class (kV)	MCOV (kV RMS)	Duty cycle rating (kV RMS)	Maximum discharge voltage (kV crest) 8 x 20 microsecond current wave				
			1.5 kA	3 kA	5 kA	10 kA	20 kA
15	2.55	3	8.06	8.48	8.74	9.36	10.4
	5.1	6	16.12	16.95	17.47	18.72	20.8
	8.4	10	28.21	29.66	30.57	32.76	36.4
	10.2	12	32.24	33.9	34.94	37.44	41.6
	12.7	15	40.3	42.38	43.68	46.8	52
	15.3	18	48.36	50.85	52.41	56.16	62.4
25	8.4	10	28.21	29.66	30.57	32.76	36.4
	10.2	12	32.24	33.9	34.94	37.44	41.6
	12.7	15	40.3	42.38	43.68	46.8	52
	15.3	18	48.36	50.85	52.41	56.16	62.4
	17	21	56.42	59.32	61.14	65.52	72.8
38	19.5	24	64.48	67.8	69.88	74.88	83.2
	22	27	72.54	76.28	78.62	84.24	93.6
	24.4	30	80.6	84.75	87.35	93.6	104
	29	36	96.72	101.7	104.82	112.32	124.8
	32.5	40.5	109.35	114.98	118.5	126.97	141.07

## Shielded surge arresters

To specify and order an MOV surge arrester:

1. Determine the appropriate maximum continuous operating voltage (MCOV) for your system voltage using the arrester application table below.
2. Specify the appropriate Elastimold catalog number from the selection chart.

Arrester application table

Voltage class (kV)	System line-to-line voltage kV RMS		MCOV* kV RMS	
	Nominal	Maximum	Solidly grounded neutral circuits	3-Wire ungrounded circuits
15	2.40	2.54	2.55	2.55
	4.16	4.40	2.55	5.10
	4.80	5.08	5.10	5.10
	6.90	7.26	5.10	8.40
	8.32	8.80	5.10	8.40
	12.47	13.20	8.40	15.30
	13.20	13.97	8.40	15.30
	13.80	14.50	8.40**	15.30
25	13.80	14.50	10.20	15.30
	6.90	7.26	5.10	8.40
	8.32	8.80	5.10	8.40
	12.47	13.20	8.40	15.30
	13.20	13.97	8.40	15.30
	13.80	14.50	8.40**	15.30
	13.80	14.50	10.20	15.30
	20.78	22.00	12.70	–
	20.78	22.00	15.30**	–
	23.00	24.34	15.30	–
	24.94	26.40	15.30	–
	24.94	26.40	17.00**	–
	28.00	29.80	17.00	–

\* MCOV = maximum continuous operating voltage.

\*\* Preferred arrester MCOV for this system voltage.

—  
Selection chart

	Description	Voltage class (kV)	Cat. no.	MCOV kV RMS
	200 A BSA bushing surge arrester (includes assembly tool)  See notes 1-4	15	167BSA-3	2.55
			167BSA-6	5.10
			167BSA-10	8.40
			167BSA-12	10.20
			167BSA-15	12.70
		25	167BSA-18	15.30
			273BSA-10	8.40
			273BSA-12	10.20
			273BSA-15	12.70
			273BSA-18	15.30
	200 A ESA elbow surge arrester  See notes 1, 2, 5	15	167ESA-3	2.55
			167ESA-6	5.10
			167ESA-10	8.40
			167ESA-12	10.20
			167ESA-15	12.70
		25	167ESA-18	15.30
			273ESA-10	8.40
			273ESA-12	10.20
			273ESA-15	12.70
			273ESA-18	15.30
	200 A PSA parking stand arrester  See notes 1-3	15	167PSA-3	2.55
			167PSA-6	5.10
			167PSA-10	8.40
			167PSA-12	10.20
			167PSA-15	12.70
		25	167PSA-18	15.30
			273PSA-10	8.40
			273PSA-12	10.20
			273PSA-15	12.70
			273PSA-18	15.30
	600 A ESA elbow surge arrester	15/28	K655ESA-10	8.4
			K655ESA-12	10.2
			K655ESA-15	12.7
			K655ESA-18	15.3
			K655ESA-21	17.0

- Note: 1. Elastimold PSA and BSA arresters are equipped with a fully rated 200 A switching and fault-close loadbreak bushing.  
 2. Elastimold arresters use high strength, silver epoxy-bonded MOV blocks and shunted spring connections for the best circuit connection.  
 3. A 36" #4 AWG ground lead is provided with each unit.  
 4. BSA installed by turning internal hex bolt (accessed through the 200 A bushing interface) with a  $\frac{5}{16}$ " hex wrench and bent-wire torque wrench supplied with each unit.  
 5. For 15 kV and 25 kV class deadbreak system elbow arresters, use catalog number 156ESA with the appropriate duty cycle rating.

## Shielded surge arresters

To specify and order an MOV surge arrester:

1. Determine the appropriate maximum continuous operating voltage (MCOV) for your system voltage using the arrester application table below.
2. Specify the appropriate Elastimold catalog number from the selection chart.

**Arrester application table**

Voltage class (kV)	System line-to-line voltage kV RMS		MCOV* kV RMS	
	Nominal	Maximum	Solidly grounded neutral circuits	3-Wire ungrounded circuits
35	23.00	24.34	–	22.00
	34.50	36.51	22.00**	–
	34.50	36.51	24.40	29.00

\* MCOV = maximum continuous operating voltage.

\*\* Preferred arrester MCOV for this system voltage.



—  
Selection chart

	Description	Voltage class (kV)	Cat. no.	MCOV kV RMS
	200 A BSA bushing surge arrester  See notes 1-4	35	375BSA-24	19.50
			375BSA-27	22.00
			375BSA-30	24.40
	200 A ESA elbow surge arrester  See notes 2-3	35	375ESA-24	19.50
			375ESA-27	22.00
			375ESA-30	24.40
			375ESA-36	29.00
	200 A PSA parking stand arrester  See notes 1-3	35	375PSA-24	19.50
			375PSA-27	22.00
			375PSA-30	24.40
	600 A ESA elbow surge arrester	35	755ESA-18	15.3
			755ESA-24	19.5
			755ESA-27	22.0
			755ESA-30	24.4
			755ESA-33	26.8
			755ESA-36	29.0
			755ESA-40.5	32.5

- Note: 1. Elastimold PSA and BSA arresters are equipped with a fully rated 200 A switching and fault-close loadbreak bushing.  
 2. Elastimold arresters use high strength, silver epoxy-bonded MOV blocks and shunted spring connections for the best circuit connection.  
 3. A 36" #4 AWG ground lead is provided with each unit.  
 4. BSA installed by turning internal hex bolt (accessed through the 200 A bushing interface) with a  $\frac{5}{16}$ " hex wrench and bent-wire torque wrench supplied with each unit.  
 5. For 15 kV and 25 kV class deadbreak system elbow arresters, use catalog number 156ESA with the appropriate duty cycle rating.

# Molded vacuum reclosers

## Single- and three-phase molded vacuum reclosers, 15–38 kV

### The recloser you want, all in one package.

The need for automated reclosers has never been greater, but many of today's reclosers come with penalties. They weigh too much, and that makes them difficult to install. They aren't easy to upgrade, so you have to guess about what features to include in case you need them several years from now. What's more, if the recloser you stock doesn't come with superior technical support, service and built-in quality, you may find it worse than no recloser at all.

Elastimold molded vacuum reclosers address all of these problems, and more.

Elastimold molded vacuum reclosers are 33% lighter than typical units today, so they're easier and less expensive to install. Modular design means smart grid sensors can be added quickly and simply. Our reclosers are compatible with SEL controls, the best in the business. Elastimold customer support, technical expertise and collaborative working relationships with customers mean that you will have the information you need, exactly when you need it.

SEL is a registered trademark of Schweitzer Engineering Laboratories, Inc.

### Smart, light and flexible.

Elastimold reclosers are world-class, by design. They respond to every hardware requirement that utilities want, and then some.

- **Smart** – Our reclosers are smart grid ready with three integral load-side voltage sensors and provision to add source-side voltage sensors, if desired. They were designed to be fully compatible with the industry's No.1 name in controls, Schweitzer Engineering Laboratories.
- **Light** – The three-phase Elastimold reclosers weigh 33% less than existing typical units. The simplicity of the mechanism design, and the compactness of the encapsulated components, contribute to making Elastimold reclosers easier to move and install.
- **Flexible** – Elastimold reclosers are modular, so field upgrades and retrofits are easy and fast. The single-phase reclosers have a pole rotation mounting bracket for easier installation.
- **Made with your needs in mind** – We designed our reclosers only after extensive talks with electric utilities. Their features, from easier-to-see open/close indicators to the many robust extra features that we consider "standard," are there because of you.

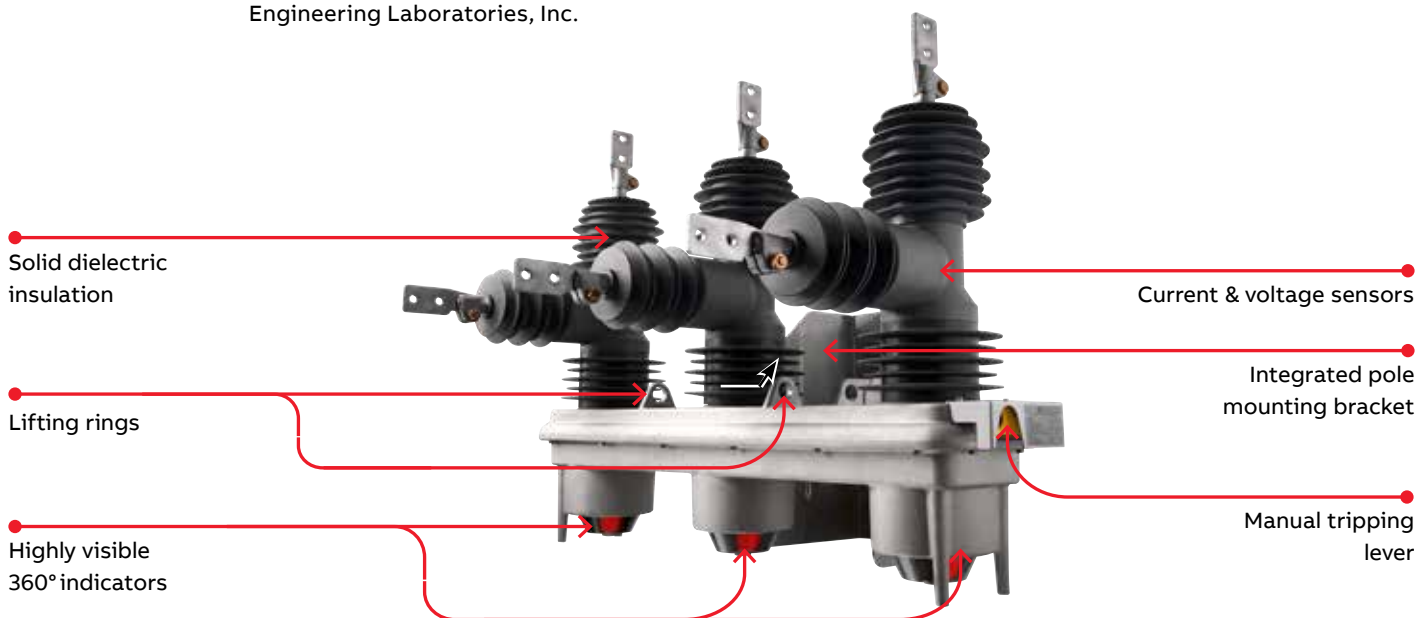

## Molded vacuum reclosers

### Recloser construction

The Elastimold molded vacuum recloser (MVR) operates electrically by energizing a magnetic actuator system with a completely sealed housing. Each pole contains a vacuum interrupter sealed in solid dielectric insulation for mechanical and high dielectric strength.

An open-closed position indicator provides a 360° view. An external manual trip assembly is located on the side; when in the down position, it maintains the recloser in a lockout position until it is manually restored. All electrical control connections are made through a sealed single-environment control cable connector on the side.

The combination of the molded vacuum recloser with microprocessor controls accurately detects a wide range of line disturbances and provides reliable, high-speed isolation for adverse conditions.

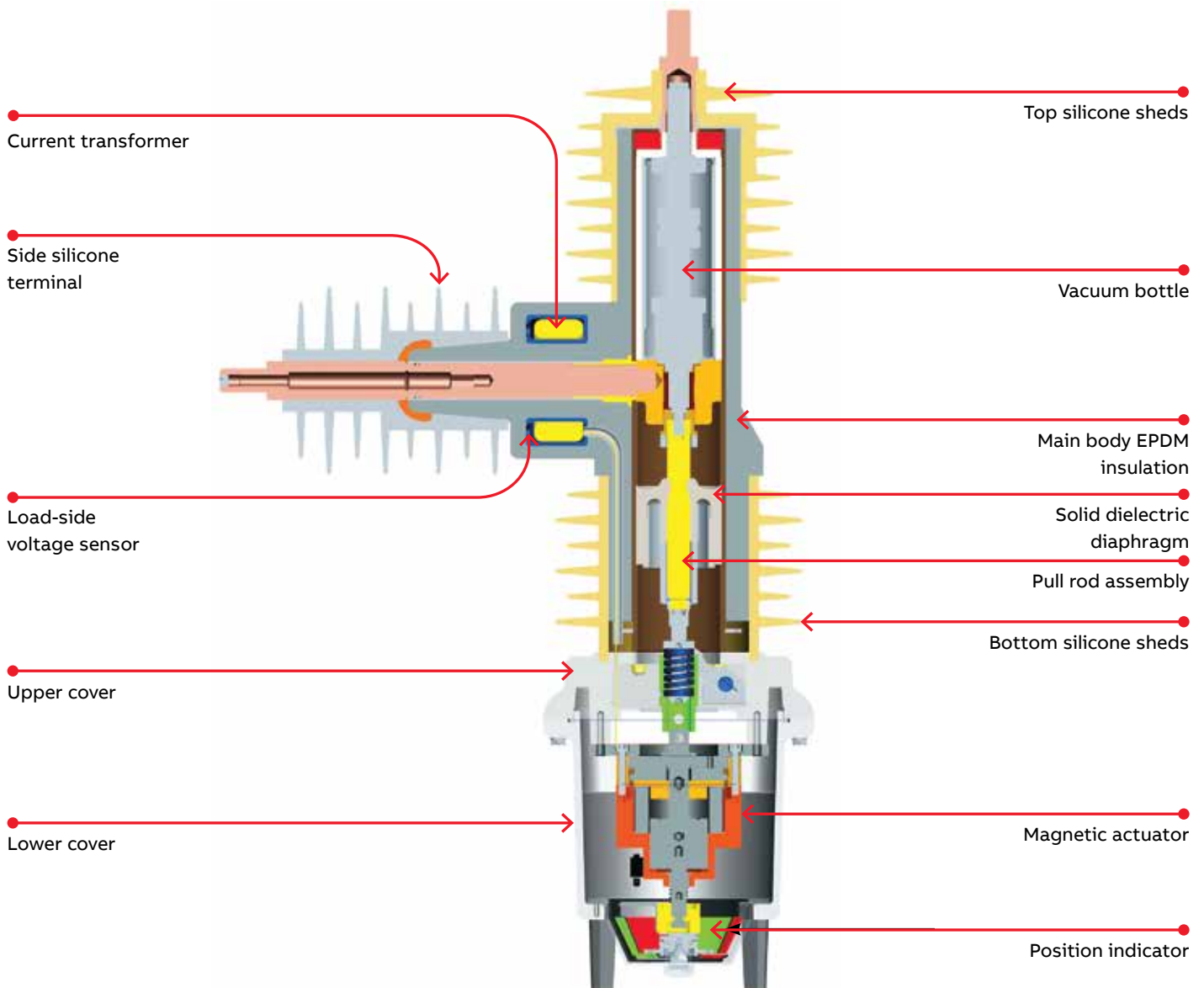

## Molded vacuum reclosers

### Elastimold single- and three-phase molded vacuum reclosers

The following diagram shows how to construct a catalog number for single- and three-phase molded vacuum reclosers.

**Example:** The catalog number for a molded vacuum recloser for a three-phase, 15 kV system, with 25.5 kA interrupting rating and three voltage sensors for use with the SEL-651R control is

**MVR-3-15-12-3-2.**

- Single-phase reclosers function with the SEL-351RS Kestrel® control. Three-phase reclosers function with SEL-651R, SEL-351R or SEL-351R Falcon™ controls. The MVR power module must be specified when using a SEL-351R and SEL-351R Falcon controls.

- Load-side voltage sensors are standard on all units and function with any SEL control having at least three 8 V AC low-energy analog (LEA) voltage inputs. All units are upgradeable to Elastimold source-side voltage sensing but require a SEL-651R x 2 control with six 8 V AC low-energy analog (LEA) inputs.

\* For complete catalog number configuration, contact your ABB sales representative.

SEL is a registered trademark of Schweitzer Engineering Laboratories, Inc.

Indicates field that must be filled in to complete order.

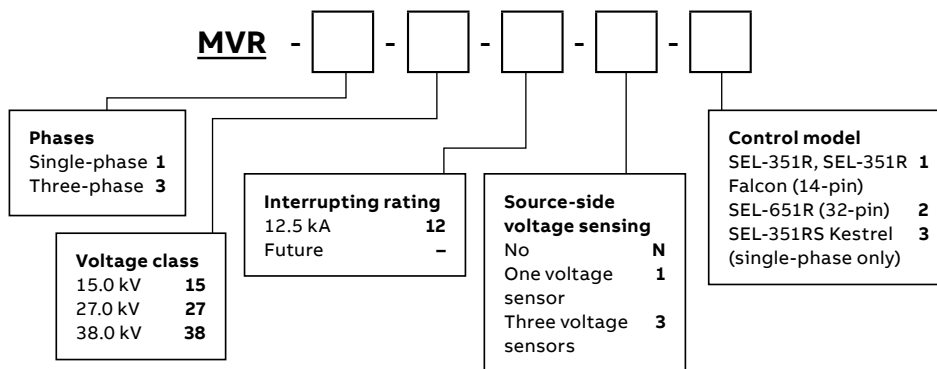

#### Accessories

Cat. no.	Accessory name/description
3188D0120G1	Three-phase line-side arrester frame
3188D0121G1	Three-phase load-side arrester frame
3188C0122G1	Single-phase line-side arrester frame
3188C0123G1	Single-phase load-side arrester frame
3070A1191P1	Wildlife protector top bushing (one per phase)
3070A1190P1	Wildlife protector side bushing (one per phase)
3188C0075G1	Source-side voltage sensors (one per phase)
3188D0119G1	Substation mounting frame
3188B0126G1	NEMA 2-hole pad
3180A0661P1	NEMA 4-hole pad
3070B0913G1	Aerial lug
1548FH-ANC3JNAA	Fisher Pierce overhead faulted circuit indicator – Adaptive Trip™; 4-hr. automatic reset time with current reset override (60 sec. after restoration of power), five ultra-bright LEDs for increased visibility display
1548FH-ANC3XNA1	Fisher Pierce overhead faulted circuit indicator – Adaptive Trip™; 4-hr. automatic reset time with current reset override (60 sec. after restoration of power), with 4-hr. temporary fault reset time, temporary fault indication option, four red and one amber LED